

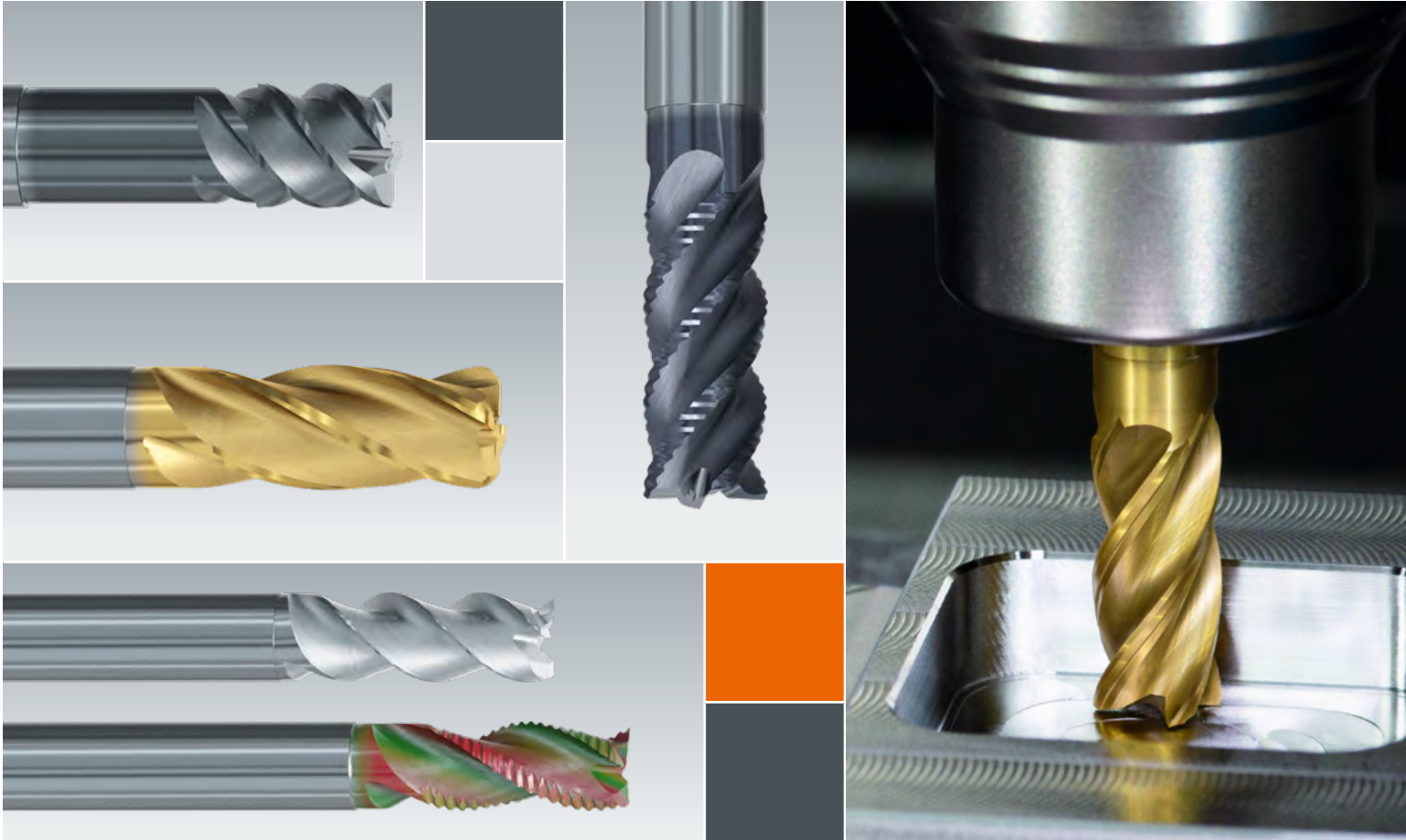

■ Made
■ in
■ Germany



Hochleistungs-Fräswerkzeuge für materialbezogene Anwendungen
High-Performance End Mills for Material-Specific Applications

FRANKEN

Hartmetall-Schaftfräser „Base“
Solid Carbide End Mills “Base”



Mehr als 100 Jahre Präzision und Innovation. More than 100 years of precision and innovation.

FRANKEN als Teil der EMUGE-FRANKEN Unternehmensgruppe beschäftigt sich seit seiner Gründung mit der Entwicklung und Produktion von Fräswerkzeugen. Präzision und Innovation prägen das breite Angebot von Fräsern aus Hartmetall und HSS sowie PKD-, CBN- oder wendeplattenbestückten Fräskörpern.

Die Fertigung am deutschen Produktionsstandort in Rückersdorf reicht von Standard-Schaft- und Bohrungsfräsern bis hin zu hochgenauen Form- und Profil-Sonderfräsern. Mit seiner Typen- und Schneidstoffvielfalt, dem hohen Standard und der kompromisslosen Präzision entspricht das Fräserprogramm den höchsten Qualitätsanforderungen.

Als Ergänzung zu den Fräswerkzeugen führen wir ein durchgängiges Programm an Fräsespannmitteln und Zubehör für die verschiedensten Adaptierungsmöglichkeiten.

Ever since its foundation FRANKEN as part of the EMUGE-FRANKEN company association has been developing and manufacturing milling tools. The wide range of end mills of solid carbide and HSS as well as PCD and CBN inserts or milling cutters with indexable inserts is characterised by precision and innovation.

The production in our German manufacturing plant in Rückersdorf includes standard end mills and bore cutters as well as highly precise special form and profile milling tools. With its large variety of tool types and cutting materials, the consistently high standards and uncompromising precision, our product range of milling cutters meets even the highest quality requirements.

In addition to our selection of milling tools, we also offer a comprehensive range of clamping systems, tool holders and accessories.

**EMUGE-FRANKEN ist nach
ISO 9001:2015 zertifiziert**
EMUGE-FRANKEN is certified
according ISO 9001:2015



www.sgs-tuev-saar.com
Certification ID
DE/819944190



Ergänzend zu unserer Universalwerkzeuglinie TOP-Cut bieten wir mit unserem „Base“-Programm Hochleistungs-Fräswerkzeuge für materialbezogene Anwendungen.

Das umfangreiche Programm an Vollhartmetall-Schafffräsern lässt dem Anwender bezüglich Vielfalt, Flexibilität und Qualität keine Wünsche offen. Alle Werkzeuge aus dem „Base“-Programm werden in gewohnter Weise aus hochwertigen Hartmetallen und modernsten Beschichtungen hergestellt. Die Geometrien der Werkzeuge sind bis ins Detail auf Performance und Prozesssicherheit ausgelegt. Somit ist sichergestellt, dass auch bei anspruchsvollsten Zerspanungsaufgaben 100% Leistung und Qualität erreicht werden.

Multi-Cut „Base“

Mit dem Multi-Cut „Base“ steht jedem Anwender, der große Volumen in niedrig- und hochlegierten Stählen zerspanen muss, ein Hochleistungs-Schruppwerkzeug zur Verfügung. Die gesamte Schneidenlänge kann dabei voll ausgenutzt werden. Auch moderne Strategien wie Trochoidal-Zyklen erledigt dieses Werkzeug gewohnt zuverlässig.

TiNox-Cut „Base“

Die speziellen Anforderungen bei der Bearbeitung von rost- und säurebeständigen Stählen sowie schwer zerspanbaren und hochfesten Werkstoffen wie Titan meistert der TiNox-Cut „Base“ problemlos. Als universeller Schafffräser für die Bereiche Maschinenbau, Chemie- und Lebensmittelindustrie sowie Aerospace stellt diese Werkzeuglinie eine perfekte Lösung für fast alle Zerspanungsaufgaben in diesen Materialien dar. Ergänzt wird die Programmlinie durch verschiedene Eckenradien an der Stirnschneide, die einen abgestimmten Einsatz auf die konstruktiven Anforderungen der Bauteile ermöglichen.

Hard-Cut „Base“

Der Hard-Cut „Base“ ist optimal zum Schrappen und Schlichten in gehärteten Stählen bis 63 HRC geeignet. Durch die neu entwickelte Geometrie in Verbindung mit einem verschleißfesten Hartmetall und einer oxidationsbeständigen Beschichtung bietet dieser Typ Performance beim Hartfräsen.

Um die maximale Standzeit zu erreichen, sind die Werkzeuge mit einem Kantenbruch zum Schutz der Schneidkante versehen.

Alu-Cut „Base“

Durch die Vielfalt des Alu-Cut „Base“ wird dem Anwender höchste Flexibilität in Verbindung mit kompromissloser Leistung und Prozesssicherheit geboten. Eine Volumenzerspanung in Aluminium ist mit allen verfügbaren Varianten – abhängig von der Maschinenstabilität – durchführbar. Mit den schlichtverzahnten Werkzeugen sind maßhaltige und hochqualitative Oberflächen einfach realisierbar, ohne die Flexibilität zu verlieren.

Neben den Schafffräsern, die mit einem Kantenbruch versehen sind, wird die Produktlinie durch verschiedene Varianten mit Eckenradius ergänzt, um für die Anforderungen am Bauteil immer das richtige Werkzeug verfügbar zu haben.

In addition to our universal tool range TOP-Cut, we offer you high-performance end mills for material-specific applications in our “Base” range of tools.

The extensive range of solid carbide end mills leaves nothing to be desired for the user in terms of variety, flexibility and quality. All tools from the “Base” range are manufactured in the usual way from high-quality carbides and state-of-the-art coatings. The geometries of the tools are designed for performance and process reliability down to the last detail. This attention to detail ensures that 100% performance and quality are achieved even with the most demanding machining tasks.

Multi-Cut “Base”

The Multi-Cut “Base” is a high-performance roughing tool and available to any user who needs to machine large volumes in low- alloy and high-alloy steels. The entire length of the cutting edge can be fully utilised. This tool also handles modern machining strategies such as trochoidal cycles reliably and without compromise.

TiNox-Cut “Base”

The TiNox-Cut “Base” easily masters the special requirements for machining stainless steels and acid-resistant steels as well as difficult-to-machine and high-strength materials such as titanium. This tool line represents a perfect solution for almost all machining tasks in these materials as a universal end mill for mechanical engineering, chemical and food industries as well as aerospace. The range of tools is supplemented by various corner radii on the face cutting edge, which enable the best possible application based on the design requirements of the components.

Hard-Cut “Base”

The Hard-Cut “Base” is optimally suited for roughing and finishing in hardened steels up to 63 HRC. This type of end mills offers unprecedented performance in hard milling thanks to the newly developed geometry in combination with an extremely wear-resistant carbide and a highly oxidation-resistant coating. The tools are provided with a bevel to protect the cutting edge and achieve the maximum tool life.

Alu-Cut “Base”

The diversity of the Alu-Cut “Base” offers the user maximum flexibility combined with uncompromising performance and process reliability. Volume machining in aluminium is feasible with all available variants - depending on the machine stability. Dimensionally accurate and high-quality surfaces are easy to machine with these finishing tools without losing flexibility.

In addition to the end mills with a bevel, the product line is supplemented by different variants with corner radius in order to always have the suitable tool available for the requirements of the component.

Wegweiser

Bitte beachten:

Die Eignung ist folgendermaßen gekennzeichnet:

- = sehr gut geeignet
- = gut geeignet

Product finder

Please note:

The suitability is indicated as follows:

- = very suitable
- = suitable

Einsatzgebiete – Material Applications – material			Material-Beispiele Material examples	Material-Nummern Material numbers
P	Stahlwerkstoffe Steel materials			
	1.1 Kaltfließpressstähle, Baustähle, Automatenstähle, u.a.	Cold-extrusion steels, Construction steels, Free-cutting steels, etc.	≤ 600 N/mm ²	Cq15 1.1132 S235JR (St37-2) 1.0037 10SPb20 1.0722
	2.1 Baustähle, Einsatzstähle, Stahlguss, u.a.	Construction steels, Case-hardened steels, Steel castings, etc.	≤ 800 N/mm ²	E360 (St70-2) 1.0070 16MnCr5 1.7131 GS-25CrMo4 1.7218
	3.1 Einsatzstähle, Vergütungsstähle, Kaltarbeitsstähle, u.a.	Case-hardened steels, Heat-treatable steels, Cold work steels, etc.	≤ 1000 N/mm ²	20MoCr3 1.7320 42CrMo4 1.7225 102Cr6 1.2067 50CrMo4 1.7228
	4.1 Vergütungsstähle, Kaltarbeitsstähle, Nitrierstähle, u.a.	Heat-treatable steels, Cold work steels, Nitriding steels, etc.	≤ 1200 N/mm ²	X45NiCrMo4 1.2767 31CrMo12 1.8515
5.1 Hochlegierte Stähle, Kaltarbeitsstähle, Warmarbeitsstähle, u.a.	High-alloyed steels, Cold work steels, Hot work steels, etc.	≤ 1400 N/mm ²	X38CrMoV5-3 1.2367 X100CrMoV8-1-1 1.2990 X40CrMoV5-1 1.2344	
M	Nichtrostende Stahlwerkstoffe Stainless steel materials			
	1.1 Ferritisch, martensitisch	Ferritic, martensitic	≤ 950 N/mm ²	X2CrTi12 1.4512
	2.1 Austenitisch	Austenitic	≤ 950 N/mm ²	X6CrNiMoTi17-12-2 1.4571
	3.1 Austenitisch-ferritisch (Duplex)	Austenitic-ferritic (Duplex)	≤ 1100 N/mm ²	X2CrNiMoN22-5-3 1.4462
4.1 Austenitisch-ferritisch hitzebeständig (Super Duplex)	Austenitic-ferritic heat-resistant (Super Duplex)	≤ 1250 N/mm ²	X2CrNiMoN25-7-4 1.4410	
K	Gusswerkstoffe Cast materials			
	1.1 Gusseisen mit Lamellengrafit (GJL)	Cast iron with lamellar graphite (GJL)	100-250 N/mm ²	EN-GJL-200 (GG20) EN-JL-1030
	2.1 Gusseisen mit Kugelgrafit (GJS)	Cast iron with nodular graphite (GJS)	250-450 N/mm ²	EN-GJL-300 (GG30) EN-JL-1050
	2.2 Gusseisen mit Kugelgrafit (GJS)	Cast iron with nodular graphite (GJS)	350-500 N/mm ²	EN-GJS-400-15 (GGG40) EN-JS-1030
	3.1 Gusseisen mit Vermiculargrafit (GJV)	Cast iron with vermicular graphite (GJV)	500-900 N/mm ²	EN-GJS-700-2 (GGG70) EN-JS-1070
	3.2 Gusseisen mit Vermiculargrafit (GJV)	Cast iron with vermicular graphite (GJV)	300-400 N/mm ²	GJV 300
	4.1 Temperguss (GTMW, GTMB)	Malleable cast iron (GTMW, GTMB)	400-500 N/mm ²	GJV 450
4.2 Temperguss (GTMW, GTMB)	Malleable cast iron (GTMW, GTMB)	250-500 N/mm ²	EN-GJMW-350-4 (GTW-35) EN-JM-1010	
4.2 Temperguss (GTMW, GTMB)	Malleable cast iron (GTMW, GTMB)	500-800 N/mm ²	EN-GJMB-450-6 (GTS-45) EN-JM-1140	
N	Nichteisenwerkstoffe Non-ferrous materials			
	Aluminium-Legierungen Aluminium alloys			
	1.1 Aluminium-Knetlegierungen	Wrought aluminium alloys	≤ 200 N/mm ²	EN AW-AIMn1 EN AW-3103
	1.2 Aluminium-Knetlegierungen	Wrought aluminium alloys	≤ 350 N/mm ²	EN AW-AIMgSi EN AW-6060
	1.3 Aluminium-Knetlegierungen	Wrought aluminium alloys	≤ 550 N/mm ²	EN AW-AlZn5Mg3Cu EN AW-7022
	1.4 Aluminium-Knetlegierungen	Wrought aluminium alloys	Si ≤ 7%	EN AC-AIMg5 EN AC-51300
	1.5 Aluminium-Gusslegierungen	Aluminium cast alloys	7% < Si ≤ 12%	EN AC-AISi9Cu3 EN AC-46500
	1.6 Aluminium-Gusslegierungen	Aluminium cast alloys	12% < Si ≤ 17%	GD-AISi17Cu4FeMg
	Kupfer-Legierungen Copper alloys			
	2.1 Reinkupfer, niedriglegiertes Kupfer	Pure copper, low-alloyed copper	≤ 400 N/mm ²	E-Cu 57
	2.2 Kupfer-Zink-Legierungen (Messing, langspanend)	Copper-zinc alloys (brass, long-chipping)	≤ 550 N/mm ²	CuZn37 (Ms63) EN CW 508 L
	2.3 Kupfer-Zink-Legierungen (Messing, kurzspanend)	Copper-zinc alloys (brass, short-chipping)	≤ 550 N/mm ²	CuZn36Pb3 (Ms58) EN CW 603 N
	2.4 Kupfer-Aluminium-Legierungen (Alubronze, langspanend)	Copper-aluminium alloys (alu bronze, long-chipping)	≤ 800 N/mm ²	CuAl10Ni5Fe4 EN CW 307 G
	2.5 Kupfer-Zinn-Legierungen (Zinnbronze, langspanend)	Copper-tin alloys (tin bronze, long-chipping)	≤ 700 N/mm ²	CuSn8P EN CW 459 K
	2.6 Kupfer-Zinn-Legierungen (Zinnbronze, kurzspanend)	Copper-tin alloys (tin bronze, short-chipping)	≤ 400 N/mm ²	CuSn7ZnPb (Rg7) 2.1090
	2.7 Kupfer-Sonderlegierungen	Special copper alloys	≤ 600 N/mm ²	(AMPCC® 8)
2.8 Kupfer-Sonderlegierungen	Special copper alloys	≤ 1400 N/mm ²	(AMPCC® 45)	
Magnesium-Legierungen Magnesium alloys				
3.1 Magnesium-Knetlegierungen	Magnesium wrought alloys	≤ 500 N/mm ²	MgAl6Zn 3.5612	
3.2 Magnesium-Gusslegierungen	Magnesium cast alloys	≤ 500 N/mm ²	EN-MCMgAl9Zn1 EN-MC21120	
Kunststoffe Synthetics				
4.1 Duroplaste (kurzspanend)	Duroplastics (short-chipping)		Bakelit, Pertinax	
4.2 Thermoplaste (langspanend)	Thermoplastics (long-chipping)		PMMA, POM, PVC	
4.3 Faserverstärkte Kunststoffe (Faseranteil ≤ 30%)	Fibre-reinforced synthetics (fibre content ≤ 30%)		GFK, CFK, AFK	
4.4 Faserverstärkte Kunststoffe (Faseranteil > 30%)	Fibre-reinforced synthetics (fibre content > 30%)		GFK, CFK, AFK	
Besondere Werkstoffe Special materials				
5.1 Grafit	Graphite		C 8000	
5.2 Wolfram-Kupfer-Legierungen	Tungsten-copper alloys		W-Cu 80/20	
5.3 Verbundwerkstoffe	Composite materials		HyLite, Alucobond	
Spezialwerkstoffe Special materials				
Titan-Legierungen Titanium alloys				
1.1 Reintitan	Pure titanium	≤ 450 N/mm ²	Ti1 3.7025	
1.2 Titan-Legierungen	Titanium alloys	≤ 900 N/mm ²	TiAl6V4 3.7165	
1.3 Titan-Legierungen	Titanium alloys	≤ 1250 N/mm ²	TiAl4Mo4Sn2 3.7185	
Nickel-, Kobalt- und Eisen-Legierungen Nickel alloys, cobalt alloys and iron alloys				
2.1 Reinnickel	Pure nickel	≤ 600 N/mm ²	Ni 99.6 2.4060	
2.2 Nickel-Basis-Legierungen	Nickel-base alloys	≤ 1000 N/mm ²	Monel 400 2.4360	
2.3 Nickel-Basis-Legierungen	Nickel-base alloys	≤ 1600 N/mm ²	Inconel 718 2.4668	
2.4 Kobalt-Basis-Legierungen	Cobalt-base alloys	≤ 1000 N/mm ²	Udimet 605	
2.5 Kobalt-Basis-Legierungen	Cobalt-base alloys	≤ 1600 N/mm ²	Haynes 25 2.4964	
2.6 Eisen-Basis-Legierungen	Iron-base alloys	≤ 1500 N/mm ²	Incoloy 800 1.4958	
Harte Werkstoffe Hard materials				
1.1 Hochfeste Stähle, gehärtete Stähle, Hartguss	High strength steels, hardened steels, hard castings	44 - 50 HRC	Weldox 1100	
1.2 Hochfeste Stähle, gehärtete Stähle, Hartguss	High strength steels, hardened steels, hard castings	50 - 55 HRC	Hardox 550	
1.3 Hochfeste Stähle, gehärtete Stähle, Hartguss	High strength steels, hardened steels, hard castings	55 - 60 HRC	ArmoX 600T	
1.4 Hochfeste Stähle, gehärtete Stähle, Hartguss	High strength steels, hardened steels, hard castings	60 - 63 HRC	Ferro-Titanit	
1.5 Hochfeste Stähle, gehärtete Stähle, Hartguss	High strength steels, hardened steels, hard castings	63 - 66 HRC	HSSE	

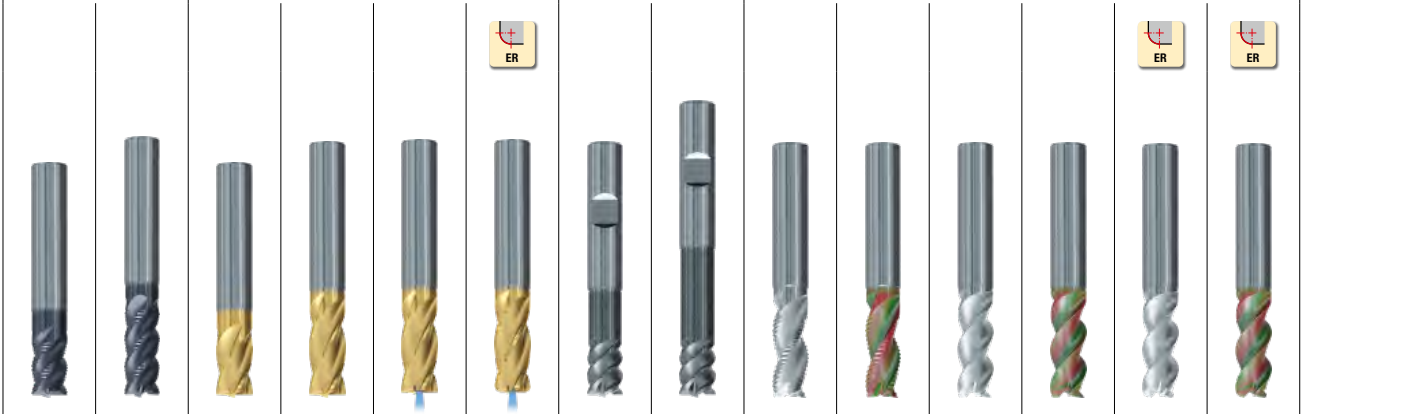

Allround		Inox				Hard materials		Al	Al/Cu	Al	Al/Cu	Al	Al/Cu	
NR	fein · fine	N				H		WR	grob · coarse					
2896A	2892A	2566T	2568T	2568TZ	2562TZ	-	-	2548	2548K	2544	2544K	2546	2546K	
2897A	2893A	2567T	2569T	2569TZ	2563TZ	3813L	3815L	2549	2549K	2545	2545K	2547	2547K	
6	6	8	10	10	12	14	16	18	18	20	20	22	22	
7	7	9	11	11	13	15	17	19	19	21	21	23	23	

														Seite · Page
														v_c / f_z
■	■	■	■	■	■	■	■							1.1
■	■	■	■	■	■	■	■							2.1
■	■	■	■	■	■	■	■							3.1
■	■	□	□	□	□	■	■							4.1
■	■	□	□	□	□	■	■							5.1
□	□	■	■	■	■									1.1
□	□	■	■	■	■									2.1
		■	■	■	■									3.1
		■	■	■	■									4.1
■	■	■	■	■	■	■	■							1.1
■	■	■	■	■	■	■	■							1.2
■	■	■	■	■	■	■	■							2.1
■	■	■	■	■	■	■	■							2.2
□	□	□	□	□	□	■	■							3.1
□	□	□	□	□	□	■	■							3.2
□	□	□	□	□	□	■	■							4.1
□	□	□	□	□	□	■	■							4.2
		■	■	■	■			■	■	■	■	■	■	1.1
		■	■	■	■			■	■	■	■	■	■	1.2
		■	■	■	■			■	■	■	■	■	■	1.3
								□	■			□	■	1.4
														1.5
														1.6
■	■	■	■	■	■				□		□		□	2.1
■	■	■	■	■	■				□		□		□	2.2
■	■	■	■	■	■	□	□		□		□		□	2.3
■	■	■	■	■	■				□		□		□	2.4
■	■	■	■	■	■				□		□		□	2.5
■	■	■	■	■	■				□		□		□	2.6
■	■	■	■	■	■				□		□		□	2.7
		■	■	■	■									2.8
														3.1
														3.2
■	■													4.1
														4.2
														4.3
														4.4
■	■	□	□	□	□	■	■							5.1
														5.2
														5.3
■	■	■	■	■	■									1.1
		□	□	□	□									1.2
		□	□	□	□									1.3
		■	■	■	■									2.1
		□	□	□	□									2.2
		□	□	□	□									2.3
		□	□	□	□									2.4
		□	□	□	□									2.5
		□	□	□	□									2.6
□	□	■	■	■	■	■	■							1.1
		□	□	□	□	■	■							1.2
						■	■							1.3
						□	□							1.4
						□	□							1.5

■ = sehr gut geeignet · very suitable
□ = gut geeignet · suitable

v_c = Schnittgeschwindigkeit · Cutting speed
 f_z = Vorschub pro Zahn · Feed per tooth

- Multifunktionales Hochleistungswerkzeug
- Sehr niedrige Schnittkräfte
- Schneiden zur Mitte
- 2 Baulängen verfügbar

- Multi-functional, high performance tool
- Very low cutting forces
- Centre cutting
- 2 lengths available

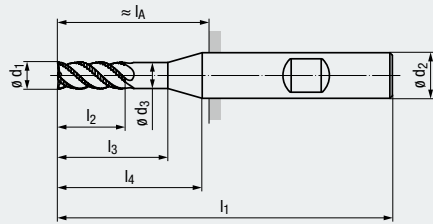
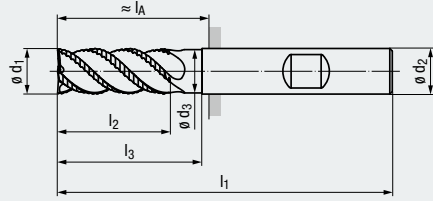
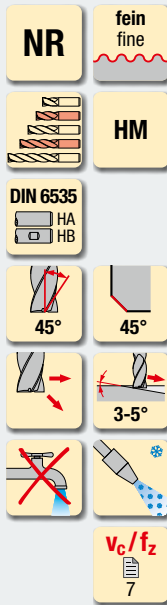

Allround

Allround

Beschichtung · Coating

Einsatzgebiete – Material (siehe Seite 4)

- In fast allen Werkstoffen einsetzbar
- Zum Schruppen bei labilen Verhältnissen hervorragend geeignet

Applications – material (see page 4)

- For almost all materials
- Suitable for roughing under unstable conditions

TIALN

TIALN

P	1.1-5.1
M	1.1-2.1
K	1.1-2.2 3.1-4.2
N	2.1-2.6, 4.1, 5.2
S	1.1
H	1.1

P	1.1-5.1
M	1.1-2.1
K	1.1-2.2 3.1-4.2
N	2.1-2.6, 4.1, 5.2
S	1.1
H	1.1

DIN 6527 – Kurze Ausführung · Short design

Bestell-Code · Order code

$\varnothing d_1$ h11	l_2	l_3	l_1	$\varnothing d_3$	l_4	$\varnothing d_2$ h6	l_A	Z (Flutes)	Dimens.- Code
3	5	9	50	2,9	14	6	14	3	.003
4	8	12	54	3,8	18	6	18	3	.004
5	9	16	54	4,8	18	6	18	3	.005
6	10	16	54	5,8	-	6	18	4	.006
8	12	20	58	7,7	-	8	22	4	.008
10	14	24	66	9,7	-	10	26	4	.010
12	16	26	73	11,6	-	12	28	4	.012
14	18	28	75	13,6	-	14	30	4	.014
16	22	32	82	15,5	-	16	34	4	.016
20	26	40	92	19,5	-	20	42	4	.020

2896A

2897A

DIN 6527 – Lange Ausführung · Long design

Bestell-Code · Order code

$\varnothing d_1$ h11	l_2	l_3	l_1	$\varnothing d_3$	l_4	$\varnothing d_2$ h6	l_A	Z (Flutes)	Dimens.- Code
3	8	14	57	2,9	20	6	21	3	.003
4	11	18	57	3,8	20	6	21	3	.004
5	13	18	57	4,8	20	6	21	3	.005
6	13	20	57	5,8	-	6	21	4	.006
8	19	25	63	7,7	-	8	27	4	.008
10	22	30	72	9,7	-	10	32	4	.010
12	26	35	83	11,6	-	12	38	4	.012
14	26	35	83	13,6	-	14	38	4	.014
16	32	40	92	15,5	-	16	44	4	.016
20	38	50	104	19,5	-	20	54	4	.020

2892A

2893A



Hartmetall-Schafffräser „Base“ – kurze und lange Ausführung
Solid carbide end mills “Base” – short and long design

NR

Gültig für · Valid for

- 2892A
- 2893A
- 2896A
- 2897A

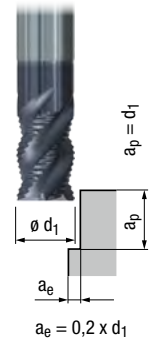
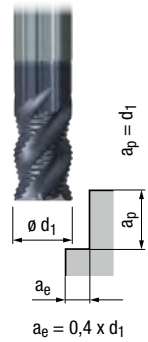
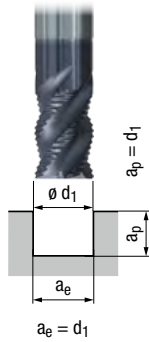

		NR							
		v_c [m/min]	f_z [mm]						
P	1.1	120	$0,005 \times d_1$	140	$0,006 \times d_1$	170	$0,007 \times d_1$		■
	2.1	110	$0,004 \times d_1$	130	$0,005 \times d_1$	150	$0,006 \times d_1$	□	■
	3.1	90	$0,004 \times d_1$	110	$0,005 \times d_1$	130	$0,005 \times d_1$	□	■
	4.1	70	$0,003 \times d_1$	80	$0,004 \times d_1$	100	$0,004 \times d_1$	□	■
	5.1	60	$0,003 \times d_1$	70	$0,003 \times d_1$	80	$0,004 \times d_1$	□	■
M	1.1	60	$0,003 \times d_1$	70	$0,004 \times d_1$	80	$0,004 \times d_1$		■
	2.1	50	$0,003 \times d_1$	60	$0,004 \times d_1$	70	$0,004 \times d_1$		■
	3.1								
	4.1								
K	1.1	120	$0,005 \times d_1$	140	$0,006 \times d_1$	170	$0,007 \times d_1$	■	■
	1.2	120	$0,005 \times d_1$	140	$0,006 \times d_1$	170	$0,007 \times d_1$	■	■
	2.1	110	$0,004 \times d_1$	130	$0,005 \times d_1$	150	$0,006 \times d_1$	■	■
	2.2	110	$0,004 \times d_1$	130	$0,005 \times d_1$	150	$0,006 \times d_1$	■	■
	3.1	90	$0,004 \times d_1$	110	$0,005 \times d_1$	130	$0,006 \times d_1$	■	■
	3.2	90	$0,004 \times d_1$	110	$0,005 \times d_1$	130	$0,006 \times d_1$	■	■
	4.1	70	$0,003 \times d_1$	80	$0,004 \times d_1$	100	$0,004 \times d_1$	■	■
	4.2	60	$0,003 \times d_1$	70	$0,004 \times d_1$	80	$0,004 \times d_1$	■	■
N	1.1								
	1.2								
	1.3								
	1.4								
	1.5								
	1.6								
	2.1	110	$0,005 \times d_1$	130	$0,006 \times d_1$	150	$0,007 \times d_1$		■
	2.2	110	$0,005 \times d_1$	130	$0,006 \times d_1$	150	$0,007 \times d_1$		■
	2.3	110	$0,005 \times d_1$	130	$0,006 \times d_1$	150	$0,007 \times d_1$	□	■
	2.4	100	$0,004 \times d_1$	120	$0,005 \times d_1$	140	$0,006 \times d_1$		■
	2.5	100	$0,004 \times d_1$	120	$0,005 \times d_1$	140	$0,006 \times d_1$		■
	2.6	100	$0,004 \times d_1$	120	$0,005 \times d_1$	140	$0,006 \times d_1$	□	■
	2.7								
	2.8								
	3.1								
	3.2								
4.1	240	$0,008 \times d_1$	290	$0,009 \times d_1$	340	$0,011 \times d_1$		■	
4.2									
4.3									
4.4									
5.1									
5.2	60	$0,003 \times d_1$	70	$0,004 \times d_1$	80	$0,004 \times d_1$		■	
5.3									
S	1.1	60	$0,004 \times d_1$	70	$0,004 \times d_1$	80	$0,005 \times d_1$		■
	1.2								
	1.3								
	2.1								
	2.2								
	2.6								
H	1.1	60	$0,003 \times d_1$	70	$0,003 \times d_1$	80	$0,004 \times d_1$	□	■
	1.2								
	1.3								
	1.4								
	1.5								

■ = sehr gut geeignet · very suitable
□ = gut geeignet · suitable

v_c = Schnittgeschwindigkeit · Cutting speed
 f_z = Vorschub pro Zahn · Feed per tooth

- Hochleistungswerkzeug
- Schlicht-Verzahnung für zähe Werkstoffe
- Keine Vibrationen durch spezielle Geometrie
- Ungleiche Teilung

- High performance tool
- Finishing end mill for tough materials
- Special geometry prevents vibration
- Variable spacing

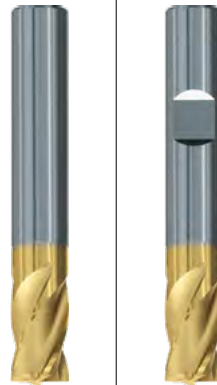
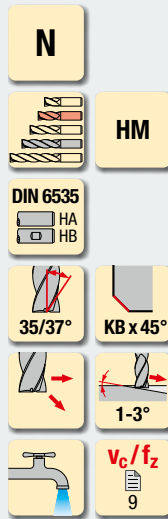
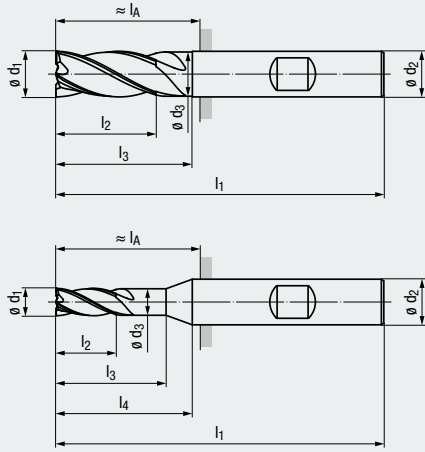

Inox

Beschichtung · Coating

Einsatzgebiete – Material (siehe Seite 4)

- Speziell für rost- und säurebeständige Stähle geeignet
- Zum HPC-Schruppen und zum Schlichten geeignet

Applications – material (see page 4)

- Especially suitable for stainless steel materials
- Suitable for HPC roughing and finishing

TIN/TIALN

P	1.1-3.1	4.1-5.1
M	1.1-4.1	
K	1.1-2.2	3.1-4.2
N	1.1-1.3	
N	2.1-2.8	5.2
S	1.1	1.2-1.3
S	2.1	2.2-2.6
H	1.1	1.2

DIN 6527 – Kurze Ausführung · Short design

Bestell-Code · Order code

Ø d ₁ h10	l ₂	l ₃	l ₁	Ø d ₃	l ₄	Ø d ₂ h6	l _A	KB	Z (Flutes)	Dimens.- Code	2566T		2567T	
3	5	9	50	2,9	14	6	14	0,07	4	.003	●	●		
4	8	12	54	3,8	18	6	18	0,07	4	.004	●	●		
5	9	16	54	4,8	18	6	18	0,12	4	.005	●	●		
6	10	16	54	5,8	–	6	18	0,12	4	.006	●	●		
8	12	20	58	7,7	–	8	22	0,12	4	.008	●	●		
10	15	24	66	9,5	–	10	26	0,2	4	.010	●	●		
12	18	26	73	11,5	–	12	28	0,2	4	.012	●	●		
16	24	32	82	15,5	–	16	34	0,2	4	.016	●	●		
20	30	40	92	19,5	–	20	42	0,3	4	.020	●	●		

Bearbeitungsbeispiel – 1.4571 mit Emulsion
Machining example – 1.4571 with emulsion

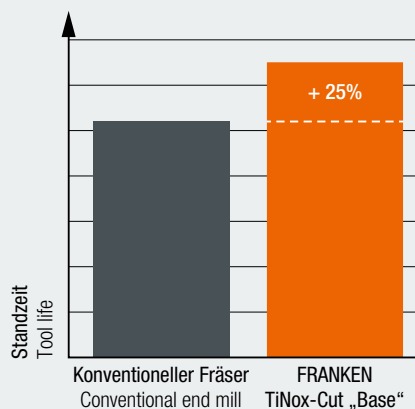
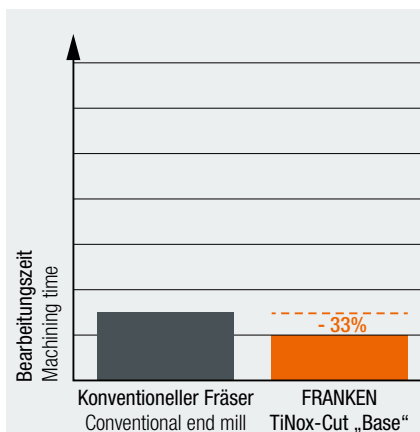

Artikel-Nr.: Article no.:	2569T.016	
Werkzeughdurchmesser: Tool diameter:	[d ₁]	16 mm
Schnittgeschwindigkeit: Cutting speed:	[v _c]	84 m/min
Vorschub pro Zahn: Feed per tooth:	[f _z]	0,064 mm
Axiale Zustellung: Axial depth of cut:	[a _p]	25 mm
Radiale Zustellung: Radial depth of cut:	[a _e]	5 mm
Drehzahl: Speed:	[n]	1 671 min ⁻¹
Vorschubgeschwindigkeit: Feed speed:	[v _f]	428 mm/min



Hartmetall-Schafffräser „Base“ – kurze Ausführung
Solid carbide end mills “Base” – short design

N

Gültig für · Valid for
2566T
2567T

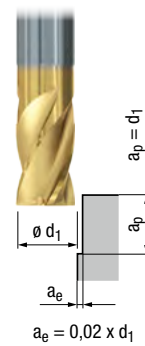
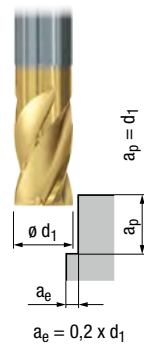
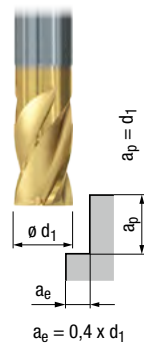
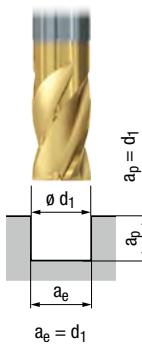

		V_c	f_z	V_c	f_z	V_c	f_z	V_c	f_z			MMS MQL	
		[m/min]	[mm]	[m/min]	[mm]	[m/min]	[mm]	[m/min]	[mm]				
P	1.1	170	$0,005 \times d_1$	190	$0,006 \times d_1$	200	$0,007 \times d_1$	240	$0,007 \times d_1$	<input type="checkbox"/>	<input type="checkbox"/>	<input type="checkbox"/>	<input checked="" type="checkbox"/>
	2.1	150	$0,004 \times d_1$	170	$0,005 \times d_1$	180	$0,006 \times d_1$	210	$0,006 \times d_1$	<input type="checkbox"/>	<input type="checkbox"/>	<input type="checkbox"/>	<input checked="" type="checkbox"/>
	3.1	130	$0,004 \times d_1$	140	$0,004 \times d_1$	160	$0,005 \times d_1$	180	$0,005 \times d_1$	<input type="checkbox"/>	<input checked="" type="checkbox"/>	<input type="checkbox"/>	<input checked="" type="checkbox"/>
	4.1	120	$0,003 \times d_1$	130	$0,004 \times d_1$	140	$0,004 \times d_1$	170	$0,004 \times d_1$	<input type="checkbox"/>	<input checked="" type="checkbox"/>	<input type="checkbox"/>	<input type="checkbox"/>
	5.1	100	$0,003 \times d_1$	110	$0,003 \times d_1$	120	$0,004 \times d_1$	140	$0,004 \times d_1$	<input type="checkbox"/>	<input checked="" type="checkbox"/>	<input type="checkbox"/>	<input type="checkbox"/>
M	1.1	90	$0,004 \times d_1$	110	$0,005 \times d_1$	120	$0,005 \times d_1$	130	$0,005 \times d_1$	<input type="checkbox"/>	<input type="checkbox"/>	<input type="checkbox"/>	<input checked="" type="checkbox"/>
	2.1	80	$0,003 \times d_1$	90	$0,004 \times d_1$	100	$0,005 \times d_1$	110	$0,005 \times d_1$	<input type="checkbox"/>	<input type="checkbox"/>	<input type="checkbox"/>	<input checked="" type="checkbox"/>
	3.1	70	$0,003 \times d_1$	80	$0,003 \times d_1$	90	$0,004 \times d_1$	100	$0,004 \times d_1$	<input type="checkbox"/>	<input type="checkbox"/>	<input type="checkbox"/>	<input checked="" type="checkbox"/>
	4.1	60	$0,002 \times d_1$	70	$0,002 \times d_1$	80	$0,003 \times d_1$	90	$0,004 \times d_1$	<input type="checkbox"/>	<input type="checkbox"/>	<input type="checkbox"/>	<input checked="" type="checkbox"/>
K	1.1	150	$0,005 \times d_1$	160	$0,006 \times d_1$	180	$0,006 \times d_1$	200	$0,007 \times d_1$	<input type="checkbox"/>	<input checked="" type="checkbox"/>	<input type="checkbox"/>	<input type="checkbox"/>
	1.2	150	$0,005 \times d_1$	160	$0,006 \times d_1$	180	$0,006 \times d_1$	200	$0,007 \times d_1$	<input type="checkbox"/>	<input checked="" type="checkbox"/>	<input type="checkbox"/>	<input type="checkbox"/>
	2.1	140	$0,004 \times d_1$	150	$0,005 \times d_1$	170	$0,005 \times d_1$	180	$0,006 \times d_1$	<input type="checkbox"/>	<input checked="" type="checkbox"/>	<input type="checkbox"/>	<input type="checkbox"/>
	2.2	140	$0,004 \times d_1$	150	$0,005 \times d_1$	170	$0,005 \times d_1$	180	$0,006 \times d_1$	<input type="checkbox"/>	<input checked="" type="checkbox"/>	<input type="checkbox"/>	<input type="checkbox"/>
	3.1	120	$0,004 \times d_1$	130	$0,005 \times d_1$	140	$0,005 \times d_1$	150	$0,006 \times d_1$	<input type="checkbox"/>	<input checked="" type="checkbox"/>	<input type="checkbox"/>	<input type="checkbox"/>
	3.2	120	$0,004 \times d_1$	130	$0,005 \times d_1$	140	$0,005 \times d_1$	150	$0,006 \times d_1$	<input type="checkbox"/>	<input checked="" type="checkbox"/>	<input type="checkbox"/>	<input type="checkbox"/>
	4.1	100	$0,003 \times d_1$	110	$0,003 \times d_1$	120	$0,004 \times d_1$	130	$0,004 \times d_1$	<input type="checkbox"/>	<input checked="" type="checkbox"/>	<input type="checkbox"/>	<input type="checkbox"/>
	4.2	80	$0,003 \times d_1$	90	$0,003 \times d_1$	90	$0,004 \times d_1$	100	$0,004 \times d_1$	<input type="checkbox"/>	<input checked="" type="checkbox"/>	<input type="checkbox"/>	<input type="checkbox"/>
N	1.1	220	$0,009 \times d_1$	250	$0,010 \times d_1$	280	$0,011 \times d_1$	300	$0,008 \times d_1$	<input type="checkbox"/>	<input type="checkbox"/>	<input type="checkbox"/>	<input checked="" type="checkbox"/>
	1.2	220	$0,008 \times d_1$	250	$0,009 \times d_1$	280	$0,010 \times d_1$	300	$0,008 \times d_1$	<input type="checkbox"/>	<input type="checkbox"/>	<input type="checkbox"/>	<input checked="" type="checkbox"/>
	1.3	220	$0,007 \times d_1$	250	$0,008 \times d_1$	280	$0,009 \times d_1$	300	$0,007 \times d_1$	<input type="checkbox"/>	<input type="checkbox"/>	<input type="checkbox"/>	<input checked="" type="checkbox"/>
	1.4									<input type="checkbox"/>	<input type="checkbox"/>	<input type="checkbox"/>	<input checked="" type="checkbox"/>
	1.5									<input type="checkbox"/>	<input type="checkbox"/>	<input type="checkbox"/>	<input checked="" type="checkbox"/>
	1.6									<input type="checkbox"/>	<input type="checkbox"/>	<input type="checkbox"/>	<input checked="" type="checkbox"/>
	2.1	170	$0,007 \times d_1$	180	$0,007 \times d_1$	200	$0,008 \times d_1$	220	$0,008 \times d_1$	<input type="checkbox"/>	<input type="checkbox"/>	<input type="checkbox"/>	<input checked="" type="checkbox"/>
	2.2	170	$0,007 \times d_1$	180	$0,007 \times d_1$	200	$0,008 \times d_1$	220	$0,008 \times d_1$	<input type="checkbox"/>	<input type="checkbox"/>	<input type="checkbox"/>	<input checked="" type="checkbox"/>
	2.3	170	$0,007 \times d_1$	180	$0,007 \times d_1$	200	$0,008 \times d_1$	220	$0,008 \times d_1$	<input type="checkbox"/>	<input type="checkbox"/>	<input type="checkbox"/>	<input checked="" type="checkbox"/>
	2.4	160	$0,006 \times d_1$	170	$0,006 \times d_1$	180	$0,007 \times d_1$	200	$0,007 \times d_1$	<input type="checkbox"/>	<input type="checkbox"/>	<input type="checkbox"/>	<input checked="" type="checkbox"/>
	2.5	160	$0,006 \times d_1$	170	$0,006 \times d_1$	180	$0,007 \times d_1$	200	$0,007 \times d_1$	<input type="checkbox"/>	<input type="checkbox"/>	<input type="checkbox"/>	<input checked="" type="checkbox"/>
	2.6	160	$0,006 \times d_1$	170	$0,006 \times d_1$	180	$0,007 \times d_1$	200	$0,007 \times d_1$	<input type="checkbox"/>	<input type="checkbox"/>	<input type="checkbox"/>	<input checked="" type="checkbox"/>
	2.7	120	$0,004 \times d_1$	130	$0,004 \times d_1$	140	$0,005 \times d_1$	160	$0,005 \times d_1$	<input type="checkbox"/>	<input type="checkbox"/>	<input type="checkbox"/>	<input checked="" type="checkbox"/>
	2.8	100	$0,003 \times d_1$	110	$0,003 \times d_1$	120	$0,004 \times d_1$	140	$0,004 \times d_1$	<input type="checkbox"/>	<input type="checkbox"/>	<input type="checkbox"/>	<input checked="" type="checkbox"/>
	3.1									<input type="checkbox"/>	<input type="checkbox"/>	<input type="checkbox"/>	<input checked="" type="checkbox"/>
	3.2									<input type="checkbox"/>	<input type="checkbox"/>	<input type="checkbox"/>	<input checked="" type="checkbox"/>
4.1									<input type="checkbox"/>	<input type="checkbox"/>	<input type="checkbox"/>	<input checked="" type="checkbox"/>	
4.2									<input type="checkbox"/>	<input type="checkbox"/>	<input type="checkbox"/>	<input checked="" type="checkbox"/>	
4.3									<input type="checkbox"/>	<input type="checkbox"/>	<input type="checkbox"/>	<input checked="" type="checkbox"/>	
4.4									<input type="checkbox"/>	<input type="checkbox"/>	<input type="checkbox"/>	<input checked="" type="checkbox"/>	
5.1									<input type="checkbox"/>	<input type="checkbox"/>	<input type="checkbox"/>	<input checked="" type="checkbox"/>	
5.2	70	$0,003 \times d_1$	80	$0,004 \times d_1$	80	$0,005 \times d_1$	100	$0,005 \times d_1$	<input type="checkbox"/>	<input type="checkbox"/>	<input type="checkbox"/>	<input checked="" type="checkbox"/>	
5.3									<input type="checkbox"/>	<input type="checkbox"/>	<input type="checkbox"/>	<input checked="" type="checkbox"/>	
S	1.1	70	$0,005 \times d_1$	90	$0,005 \times d_1$	100	$0,006 \times d_1$	100	$0,005 \times d_1$	<input type="checkbox"/>	<input type="checkbox"/>	<input type="checkbox"/>	<input checked="" type="checkbox"/>
	1.2	60	$0,003 \times d_1$	70	$0,003 \times d_1$	80	$0,004 \times d_1$	90	$0,004 \times d_1$	<input type="checkbox"/>	<input type="checkbox"/>	<input type="checkbox"/>	<input checked="" type="checkbox"/>
	1.3	50	$0,002 \times d_1$	60	$0,002 \times d_1$	70	$0,003 \times d_1$	80	$0,003 \times d_1$	<input type="checkbox"/>	<input type="checkbox"/>	<input type="checkbox"/>	<input checked="" type="checkbox"/>
	2.1	60	$0,003 \times d_1$	70	$0,003 \times d_1$	80	$0,004 \times d_1$	90	$0,004 \times d_1$	<input type="checkbox"/>	<input type="checkbox"/>	<input type="checkbox"/>	<input checked="" type="checkbox"/>
	2.2	20	$0,002 \times d_1$	25	$0,002 \times d_1$	30	$0,003 \times d_1$	35	$0,003 \times d_1$	<input type="checkbox"/>	<input type="checkbox"/>	<input type="checkbox"/>	<input checked="" type="checkbox"/>
	2.3	15	$0,002 \times d_1$	20	$0,002 \times d_1$	25	$0,003 \times d_1$	30	$0,003 \times d_1$	<input type="checkbox"/>	<input type="checkbox"/>	<input type="checkbox"/>	<input checked="" type="checkbox"/>
	2.4	20	$0,002 \times d_1$	25	$0,002 \times d_1$	30	$0,003 \times d_1$	35	$0,003 \times d_1$	<input type="checkbox"/>	<input type="checkbox"/>	<input type="checkbox"/>	<input checked="" type="checkbox"/>
2.5	15	$0,002 \times d_1$	20	$0,002 \times d_1$	25	$0,003 \times d_1$	30	$0,003 \times d_1$	<input type="checkbox"/>	<input type="checkbox"/>	<input type="checkbox"/>	<input checked="" type="checkbox"/>	
2.6	15	$0,002 \times d_1$	20	$0,002 \times d_1$	25	$0,003 \times d_1$	30	$0,003 \times d_1$	<input type="checkbox"/>	<input type="checkbox"/>	<input type="checkbox"/>	<input checked="" type="checkbox"/>	
H	1.1	90	$0,003 \times d_1$	100	$0,003 \times d_1$	110	$0,003 \times d_1$	130	$0,004 \times d_1$	<input type="checkbox"/>	<input checked="" type="checkbox"/>	<input type="checkbox"/>	<input type="checkbox"/>
	1.2	70	$0,002 \times d_1$	80	$0,003 \times d_1$	90	$0,003 \times d_1$	110	$0,004 \times d_1$	<input type="checkbox"/>	<input checked="" type="checkbox"/>	<input type="checkbox"/>	<input type="checkbox"/>
	1.3									<input type="checkbox"/>	<input type="checkbox"/>	<input type="checkbox"/>	<input checked="" type="checkbox"/>
	1.4									<input type="checkbox"/>	<input type="checkbox"/>	<input type="checkbox"/>	<input checked="" type="checkbox"/>
	1.5									<input type="checkbox"/>	<input type="checkbox"/>	<input type="checkbox"/>	<input checked="" type="checkbox"/>

■ = sehr gut geeignet · very suitable
□ = gut geeignet · suitable

V_c = Schnittgeschwindigkeit · Cutting speed
 f_z = Vorschub pro Zahn · Feed per tooth

- Hochleistungswerkzeug
- Schlicht-Verzahnung für zähe Werkstoffe
- Keine Vibrationen durch spezielle Geometrie
- Innere Kühlschmierstoff-Zufuhr, Austritt axial (ICA)
- Ungleiche Teilung

- High performance tool
- Finishing end mill for tough materials
- Special geometry prevents vibration
- Internal coolant supply, axial exit (ICA)
- Variable spacing

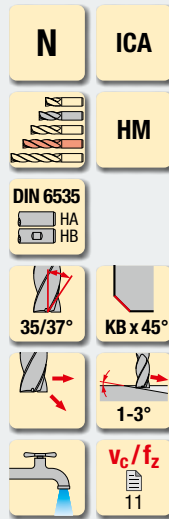
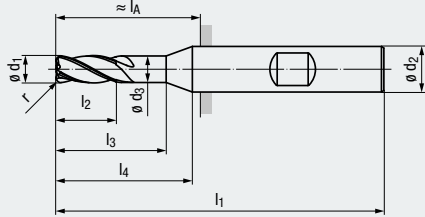
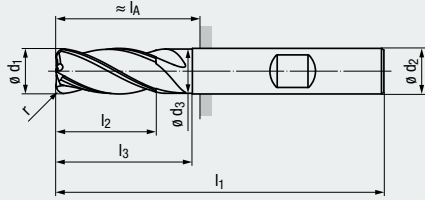

Inox

Inox

Beschichtung · Coating

Einsatzgebiete – Material (siehe Seite 4)

- Speziell für rost- und säurebeständige Stähle geeignet
- Zum HPC-Schruppen und zum Schlichten geeignet

Applications – material (see page 4)

- Especially suitable for stainless steel materials
- Suitable for HPC roughing and finishing

TIN/TIALN

P	1.1-3.1	4.1-5.1
M	1.1-4.1	
K	1.1-2.2	3.1-4.2
N	1.1-1.3	
N	2.1-2.8	5.2
S	1.1	1.2-1.3
S	2.1	2.2-2.6
H	1.1	1.2

TIN/TIALN

P	1.1-3.1	4.1-5.1
M	1.1-4.1	
K	1.1-2.2	3.1-4.2
N	1.1-1.3	
N	2.1-2.8	5.2
S	1.1	1.2-1.3
S	2.1	2.2-2.6
H	1.1	1.2

DIN 6527 – Lange Ausführung · Long design

Bestell-Code · Order code											2568T	2569T	2568TZ	2569TZ
$\varnothing d_1$ h10	l_2	l_3	l_1	$\varnothing d_3$	l_4	$\varnothing d_2$ h6	l_A 	KB	Z (Flutes)	Dimens.- Code				
3	8	14	57	2,9	20	6	21	0,07	4	.003	●	●	●	●
4	11	18	57	3,8	20	6	21	0,07	4	.004	●	●	●	●
5	13	19	57	4,8	20	6	21	0,12	4	.005	●	●	●	●
6	13	20	57	5,8	—	6	21	0,12	4	.006	●	●	●	●
8	21	25	63	7,7	—	8	27	0,12	4	.008	●	●	●	●
10	22	30	72	9,5	—	10	32	0,2	4	.010	●	●	●	●
12	26	35	83	11,5	—	12	38	0,2	4	.012	●	●	●	●
14	26	35	83	13,5	—	16	38	0,2	4	.014	●	●	●	●
16	36	42	92	15,5	—	16	44	0,2	4	.016	●	●	●	●
20	41	52	104	19,5	—	20	54	0,3	4	.020	●	●	●	●



Hartmetall-Schafffräser „Base“ – lange Ausführung
Solid carbide end mills “Base” – long design

N

Gültig für · Valid for

2568T
2568TZ
2569T
2569TZ

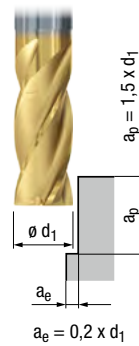
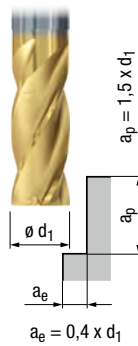
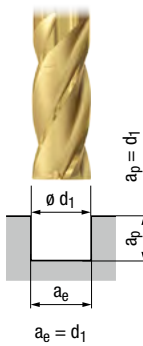

		V_c	f_z	V_c	f_z	V_c	f_z	V_c	f_z				
		[m/min]	[mm]	[m/min]	[mm]	[m/min]	[mm]	[m/min]	[mm]				
P	1.1	140	$0,005 \times d_1$	150	$0,006 \times d_1$	170	$0,007 \times d_1$	200	$0,007 \times d_1$	<input type="checkbox"/>	<input type="checkbox"/>	<input type="checkbox"/>	<input checked="" type="checkbox"/>
	2.1	130	$0,004 \times d_1$	140	$0,005 \times d_1$	160	$0,006 \times d_1$	180	$0,006 \times d_1$	<input type="checkbox"/>	<input type="checkbox"/>	<input type="checkbox"/>	<input checked="" type="checkbox"/>
	3.1	110	$0,004 \times d_1$	120	$0,004 \times d_1$	130	$0,005 \times d_1$	150	$0,005 \times d_1$	<input type="checkbox"/>	<input checked="" type="checkbox"/>	<input type="checkbox"/>	<input checked="" type="checkbox"/>
	4.1	100	$0,003 \times d_1$	110	$0,004 \times d_1$	120	$0,004 \times d_1$	140	$0,004 \times d_1$	<input type="checkbox"/>	<input checked="" type="checkbox"/>	<input type="checkbox"/>	<input type="checkbox"/>
	5.1	90	$0,003 \times d_1$	100	$0,003 \times d_1$	110	$0,004 \times d_1$	130	$0,004 \times d_1$	<input type="checkbox"/>	<input checked="" type="checkbox"/>	<input type="checkbox"/>	<input type="checkbox"/>
M	1.1	80	$0,004 \times d_1$	100	$0,005 \times d_1$	110	$0,005 \times d_1$	120	$0,005 \times d_1$	<input type="checkbox"/>	<input type="checkbox"/>	<input type="checkbox"/>	<input checked="" type="checkbox"/>
	2.1	70	$0,003 \times d_1$	80	$0,004 \times d_1$	90	$0,005 \times d_1$	100	$0,005 \times d_1$	<input type="checkbox"/>	<input type="checkbox"/>	<input type="checkbox"/>	<input checked="" type="checkbox"/>
	3.1	60	$0,003 \times d_1$	70	$0,004 \times d_1$	80	$0,004 \times d_1$	90	$0,004 \times d_1$	<input type="checkbox"/>	<input type="checkbox"/>	<input type="checkbox"/>	<input checked="" type="checkbox"/>
	4.1	50	$0,002 \times d_1$	60	$0,003 \times d_1$	70	$0,003 \times d_1$	80	$0,004 \times d_1$	<input type="checkbox"/>	<input type="checkbox"/>	<input type="checkbox"/>	<input checked="" type="checkbox"/>
K	1.1	140	$0,005 \times d_1$	150	$0,006 \times d_1$	170	$0,006 \times d_1$	200	$0,007 \times d_1$	<input type="checkbox"/>	<input checked="" type="checkbox"/>	<input type="checkbox"/>	<input type="checkbox"/>
	1.2	140	$0,005 \times d_1$	150	$0,006 \times d_1$	170	$0,006 \times d_1$	200	$0,007 \times d_1$	<input type="checkbox"/>	<input checked="" type="checkbox"/>	<input type="checkbox"/>	<input type="checkbox"/>
	2.1	130	$0,004 \times d_1$	140	$0,005 \times d_1$	160	$0,005 \times d_1$	180	$0,006 \times d_1$	<input type="checkbox"/>	<input checked="" type="checkbox"/>	<input type="checkbox"/>	<input type="checkbox"/>
	2.2	130	$0,004 \times d_1$	140	$0,005 \times d_1$	160	$0,005 \times d_1$	180	$0,006 \times d_1$	<input type="checkbox"/>	<input checked="" type="checkbox"/>	<input type="checkbox"/>	<input type="checkbox"/>
	3.1	110	$0,004 \times d_1$	120	$0,005 \times d_1$	130	$0,005 \times d_1$	150	$0,006 \times d_1$	<input type="checkbox"/>	<input checked="" type="checkbox"/>	<input type="checkbox"/>	<input type="checkbox"/>
	3.2	110	$0,004 \times d_1$	120	$0,005 \times d_1$	130	$0,005 \times d_1$	150	$0,006 \times d_1$	<input type="checkbox"/>	<input checked="" type="checkbox"/>	<input type="checkbox"/>	<input type="checkbox"/>
	4.1	90	$0,003 \times d_1$	100	$0,003 \times d_1$	110	$0,004 \times d_1$	130	$0,004 \times d_1$	<input type="checkbox"/>	<input checked="" type="checkbox"/>	<input type="checkbox"/>	<input type="checkbox"/>
	4.2	70	$0,003 \times d_1$	80	$0,003 \times d_1$	80	$0,004 \times d_1$	100	$0,004 \times d_1$	<input type="checkbox"/>	<input checked="" type="checkbox"/>	<input type="checkbox"/>	<input type="checkbox"/>
N	1.1	220	$0,009 \times d_1$	250	$0,010 \times d_1$	280	$0,011 \times d_1$	300	$0,008 \times d_1$	<input type="checkbox"/>	<input type="checkbox"/>	<input type="checkbox"/>	<input checked="" type="checkbox"/>
	1.2	220	$0,008 \times d_1$	250	$0,009 \times d_1$	280	$0,010 \times d_1$	300	$0,008 \times d_1$	<input type="checkbox"/>	<input type="checkbox"/>	<input type="checkbox"/>	<input checked="" type="checkbox"/>
	1.3	220	$0,007 \times d_1$	250	$0,008 \times d_1$	280	$0,009 \times d_1$	300	$0,007 \times d_1$	<input type="checkbox"/>	<input type="checkbox"/>	<input type="checkbox"/>	<input checked="" type="checkbox"/>
	1.4									<input type="checkbox"/>	<input type="checkbox"/>	<input type="checkbox"/>	<input checked="" type="checkbox"/>
	1.5									<input type="checkbox"/>	<input type="checkbox"/>	<input type="checkbox"/>	<input checked="" type="checkbox"/>
	1.6									<input type="checkbox"/>	<input type="checkbox"/>	<input type="checkbox"/>	<input checked="" type="checkbox"/>
	2.1	170	$0,007 \times d_1$	180	$0,007 \times d_1$	200	$0,008 \times d_1$	220	$0,008 \times d_1$	<input type="checkbox"/>	<input type="checkbox"/>	<input type="checkbox"/>	<input checked="" type="checkbox"/>
	2.2	170	$0,007 \times d_1$	180	$0,007 \times d_1$	200	$0,008 \times d_1$	220	$0,008 \times d_1$	<input type="checkbox"/>	<input type="checkbox"/>	<input type="checkbox"/>	<input checked="" type="checkbox"/>
	2.3	170	$0,007 \times d_1$	180	$0,007 \times d_1$	200	$0,008 \times d_1$	220	$0,008 \times d_1$	<input type="checkbox"/>	<input type="checkbox"/>	<input type="checkbox"/>	<input checked="" type="checkbox"/>
	2.4	160	$0,006 \times d_1$	170	$0,006 \times d_1$	180	$0,007 \times d_1$	200	$0,007 \times d_1$	<input type="checkbox"/>	<input type="checkbox"/>	<input type="checkbox"/>	<input checked="" type="checkbox"/>
	2.5	160	$0,006 \times d_1$	170	$0,006 \times d_1$	180	$0,007 \times d_1$	200	$0,007 \times d_1$	<input type="checkbox"/>	<input type="checkbox"/>	<input type="checkbox"/>	<input checked="" type="checkbox"/>
	2.6	160	$0,006 \times d_1$	170	$0,006 \times d_1$	180	$0,007 \times d_1$	200	$0,007 \times d_1$	<input type="checkbox"/>	<input type="checkbox"/>	<input type="checkbox"/>	<input checked="" type="checkbox"/>
	2.7	120	$0,004 \times d_1$	130	$0,004 \times d_1$	140	$0,005 \times d_1$	160	$0,005 \times d_1$	<input type="checkbox"/>	<input type="checkbox"/>	<input type="checkbox"/>	<input checked="" type="checkbox"/>
	2.8	100	$0,003 \times d_1$	110	$0,003 \times d_1$	120	$0,004 \times d_1$	140	$0,004 \times d_1$	<input type="checkbox"/>	<input type="checkbox"/>	<input type="checkbox"/>	<input checked="" type="checkbox"/>
	3.1									<input type="checkbox"/>	<input type="checkbox"/>	<input type="checkbox"/>	<input checked="" type="checkbox"/>
	3.2									<input type="checkbox"/>	<input type="checkbox"/>	<input type="checkbox"/>	<input checked="" type="checkbox"/>
4.1									<input type="checkbox"/>	<input type="checkbox"/>	<input type="checkbox"/>	<input checked="" type="checkbox"/>	
4.2									<input type="checkbox"/>	<input type="checkbox"/>	<input type="checkbox"/>	<input checked="" type="checkbox"/>	
4.3									<input type="checkbox"/>	<input type="checkbox"/>	<input type="checkbox"/>	<input checked="" type="checkbox"/>	
4.4									<input type="checkbox"/>	<input type="checkbox"/>	<input type="checkbox"/>	<input checked="" type="checkbox"/>	
5.1									<input type="checkbox"/>	<input type="checkbox"/>	<input type="checkbox"/>	<input checked="" type="checkbox"/>	
5.2	70	$0,003 \times d_1$	80	$0,004 \times d_1$	80	$0,005 \times d_1$	100	$0,005 \times d_1$	<input type="checkbox"/>	<input type="checkbox"/>	<input type="checkbox"/>	<input checked="" type="checkbox"/>	
5.3									<input type="checkbox"/>	<input type="checkbox"/>	<input type="checkbox"/>	<input checked="" type="checkbox"/>	
S	1.1	70	$0,005 \times d_1$	90	$0,005 \times d_1$	100	$0,006 \times d_1$	100	$0,005 \times d_1$	<input type="checkbox"/>	<input type="checkbox"/>	<input type="checkbox"/>	<input checked="" type="checkbox"/>
	1.2	60	$0,003 \times d_1$	70	$0,003 \times d_1$	80	$0,004 \times d_1$	90	$0,004 \times d_1$	<input type="checkbox"/>	<input type="checkbox"/>	<input type="checkbox"/>	<input checked="" type="checkbox"/>
	1.3	50	$0,002 \times d_1$	60	$0,002 \times d_1$	70	$0,003 \times d_1$	80	$0,003 \times d_1$	<input type="checkbox"/>	<input type="checkbox"/>	<input type="checkbox"/>	<input checked="" type="checkbox"/>
	2.1	60	$0,003 \times d_1$	70	$0,003 \times d_1$	80	$0,004 \times d_1$	90	$0,004 \times d_1$	<input type="checkbox"/>	<input type="checkbox"/>	<input type="checkbox"/>	<input checked="" type="checkbox"/>
	2.2	20	$0,002 \times d_1$	25	$0,002 \times d_1$	30	$0,003 \times d_1$	35	$0,003 \times d_1$	<input type="checkbox"/>	<input type="checkbox"/>	<input type="checkbox"/>	<input checked="" type="checkbox"/>
	2.3	15	$0,002 \times d_1$	20	$0,002 \times d_1$	25	$0,003 \times d_1$	30	$0,003 \times d_1$	<input type="checkbox"/>	<input type="checkbox"/>	<input type="checkbox"/>	<input checked="" type="checkbox"/>
	2.4	20	$0,002 \times d_1$	25	$0,002 \times d_1$	30	$0,003 \times d_1$	35	$0,003 \times d_1$	<input type="checkbox"/>	<input type="checkbox"/>	<input type="checkbox"/>	<input checked="" type="checkbox"/>
2.5	15	$0,002 \times d_1$	20	$0,002 \times d_1$	25	$0,003 \times d_1$	30	$0,003 \times d_1$	<input type="checkbox"/>	<input type="checkbox"/>	<input type="checkbox"/>	<input checked="" type="checkbox"/>	
2.6	15	$0,002 \times d_1$	20	$0,002 \times d_1$	25	$0,003 \times d_1$	30	$0,003 \times d_1$	<input type="checkbox"/>	<input type="checkbox"/>	<input type="checkbox"/>	<input checked="" type="checkbox"/>	
H	1.1	90	$0,003 \times d_1$	100	$0,003 \times d_1$	110	$0,003 \times d_1$	130	$0,004 \times d_1$	<input type="checkbox"/>	<input checked="" type="checkbox"/>	<input type="checkbox"/>	<input type="checkbox"/>
	1.2	70	$0,002 \times d_1$	80	$0,003 \times d_1$	90	$0,003 \times d_1$	110	$0,004 \times d_1$	<input type="checkbox"/>	<input checked="" type="checkbox"/>	<input type="checkbox"/>	<input type="checkbox"/>
	1.3									<input type="checkbox"/>	<input type="checkbox"/>	<input type="checkbox"/>	<input checked="" type="checkbox"/>
	1.4									<input type="checkbox"/>	<input type="checkbox"/>	<input type="checkbox"/>	<input checked="" type="checkbox"/>
	1.5									<input type="checkbox"/>	<input type="checkbox"/>	<input type="checkbox"/>	<input checked="" type="checkbox"/>

■ = sehr gut geeignet · very suitable
□ = gut geeignet · suitable

V_c = Schnittgeschwindigkeit · Cutting speed
 f_z = Vorschub pro Zahn · Feed per tooth

- Hochleistungswerkzeug
- Schlicht-Verzahnung für zähe Werkstoffe
- Keine Vibrationen durch spezielle Geometrie
- Verschiedene Eckenradien pro Schneidendurchmesser
- Innere Kühlschmierstoff-Zufuhr, Austritt axial (ICA)
- Ungleiche Teilung
- High performance tool
- Finishing end mill for tough materials
- Special geometry prevents vibration
- Several corner radii per cutting diameter
- Internal coolant supply, axial exit (ICA)
- Variable spacing

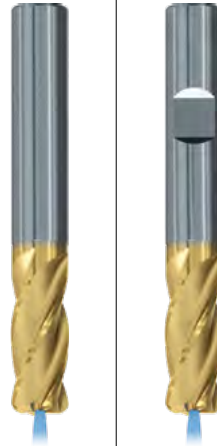
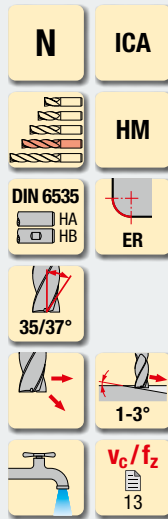
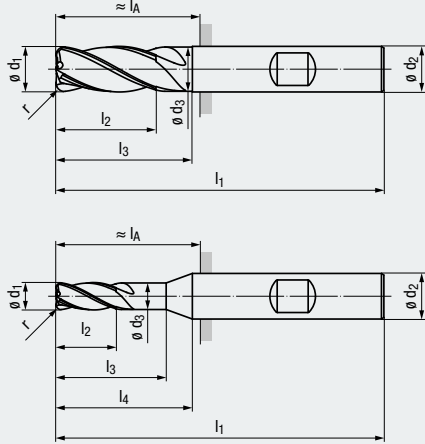

Inox

Beschichtung · Coating

Einsatzgebiete – Material (siehe Seite 4)

- Speziell für rost- und säurebeständige Stähle geeignet
- Zum HPC-Schruppen und zum Schlichten geeignet

Applications – material (see page 4)

- Especially suitable for stainless steel materials
- Suitable for HPC roughing and finishing

TIN/TIALN

P	1.1-3.1	4.1-5.1
M	1.1-4.1	
K	1.1-2.2	3.1-4.2
N	1.1-1.3	
N	2.1-2.8	5.2
S	1.1	1.2-1.3
S	2.1	2.2-2.6
H	1.1	1.2

DIN 6527 – Lange Ausführung · Long design

Eckenradius · Corner radius

Bestell-Code · Order code

												2562TZ	2563TZ		
θd_1 h10	r $\pm 0,01$	l_2	l_3	l_1	θd_3	l_4	θd_2 h6	l_A 	Z (Flutes)	Dimens.- Code					
3	0,1	8	14	57	2,9	20	6	21	4	.003001	●	●			
3	0,3	8	14	57	2,9	20	6	21	4	.003003	●	●			
3	0,5	8	14	57	2,9	20	6	21	4	.003005	●	●			
4	0,3	11	18	57	3,8	20	6	21	4	.004003	●	●			
4	0,5	11	18	57	3,8	20	6	21	4	.004005	●	●			
5	0,5	13	19	57	4,8	20	6	21	4	.005005	●	●			
5	1	13	19	57	4,8	20	6	21	4	.005010	●	●			
6	0,5	13	20	57	5,8	—	6	21	4	.006005	●	●			
6	1	13	20	57	5,8	—	6	21	4	.006010	●	●			
8	0,5	21	25	63	7,7	—	8	27	4	.008005	●	●			
8	1	21	25	63	7,7	—	8	27	4	.008010	●	●			
8	2	21	25	63	7,7	—	8	27	4	.008020	●	●			
10	0,5	22	30	72	9,5	—	10	32	4	.010005	●	●			
10	1	22	30	72	9,5	—	10	32	4	.010010	●	●			
10	2	22	30	72	9,5	—	10	32	4	.010020	●	●			
12	0,5	26	35	83	11,5	—	12	38	4	.012005	●	●			
12	1	26	35	83	11,5	—	12	38	4	.012010	●	●			
12	2	26	35	83	11,5	—	12	38	4	.012020	●	●			
12	2,5	26	35	83	11,5	—	12	38	4	.012025	●	new	●	new	
12	3	26	35	83	11,5	—	12	38	4	.012030	●	new	●	new	
12	4	26	35	83	11,5	—	12	38	4	.012040	●	new	●	new	
16	1	36	42	92	15,5	—	16	44	4	.016010	●	●			
16	2	36	42	92	15,5	—	16	44	4	.016020	●	●			
16	2,5	36	42	92	15,5	—	16	44	4	.016025	●	new	●	new	
16	3	36	42	92	15,5	—	16	44	4	.016030	●	●			
16	4	36	42	92	15,5	—	16	44	4	.016040	●	new	●	new	
20	1	41	52	104	19,5	—	20	54	4	.020010	●	new	●	new	
20	2	41	52	104	19,5	—	20	54	4	.020020	●	●			
20	2,5	41	52	104	19,5	—	20	54	4	.020025	●	new	●	new	
20	3	41	52	104	19,5	—	20	54	4	.020030	●	●			
20	4	41	52	104	19,5	—	20	54	4	.020040	●	●			



Hartmetall-Schafffräser „Base“ – lange Ausführung
Solid carbide end mills “Base” – long design

N

Gültig für · Valid for
2562TZ
2563TZ

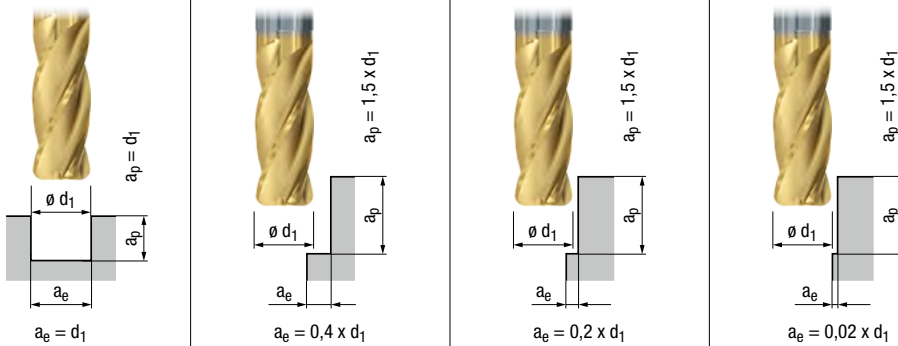

		V_c	f_z	V_c	f_z	V_c	f_z	V_c	f_z			MMS MQL	
		[m/min]	[mm]	[m/min]	[mm]	[m/min]	[mm]	[m/min]	[mm]				
P	1.1	140	$0,005 \times d_1$	150	$0,006 \times d_1$	170	$0,007 \times d_1$	200	$0,007 \times d_1$	<input type="checkbox"/>	<input type="checkbox"/>	<input type="checkbox"/>	<input checked="" type="checkbox"/>
	2.1	130	$0,004 \times d_1$	140	$0,005 \times d_1$	160	$0,006 \times d_1$	180	$0,006 \times d_1$	<input type="checkbox"/>	<input type="checkbox"/>	<input type="checkbox"/>	<input checked="" type="checkbox"/>
	3.1	110	$0,004 \times d_1$	120	$0,004 \times d_1$	130	$0,005 \times d_1$	150	$0,005 \times d_1$	<input type="checkbox"/>	<input checked="" type="checkbox"/>	<input type="checkbox"/>	<input checked="" type="checkbox"/>
	4.1	100	$0,003 \times d_1$	110	$0,004 \times d_1$	120	$0,004 \times d_1$	140	$0,004 \times d_1$	<input type="checkbox"/>	<input checked="" type="checkbox"/>		
	5.1	90	$0,003 \times d_1$	100	$0,003 \times d_1$	110	$0,004 \times d_1$	130	$0,004 \times d_1$	<input type="checkbox"/>	<input checked="" type="checkbox"/>		
M	1.1	80	$0,004 \times d_1$	100	$0,005 \times d_1$	110	$0,005 \times d_1$	120	$0,005 \times d_1$	<input type="checkbox"/>	<input type="checkbox"/>	<input type="checkbox"/>	<input checked="" type="checkbox"/>
	2.1	70	$0,003 \times d_1$	80	$0,004 \times d_1$	90	$0,005 \times d_1$	100	$0,005 \times d_1$	<input type="checkbox"/>	<input type="checkbox"/>	<input type="checkbox"/>	<input checked="" type="checkbox"/>
	3.1	60	$0,003 \times d_1$	70	$0,004 \times d_1$	80	$0,004 \times d_1$	90	$0,004 \times d_1$			<input type="checkbox"/>	<input checked="" type="checkbox"/>
	4.1	50	$0,002 \times d_1$	60	$0,003 \times d_1$	70	$0,003 \times d_1$	80	$0,004 \times d_1$			<input type="checkbox"/>	<input checked="" type="checkbox"/>
K	1.1	140	$0,005 \times d_1$	150	$0,006 \times d_1$	170	$0,006 \times d_1$	200	$0,007 \times d_1$	<input type="checkbox"/>	<input checked="" type="checkbox"/>		<input type="checkbox"/>
	1.2	140	$0,005 \times d_1$	150	$0,006 \times d_1$	170	$0,006 \times d_1$	200	$0,007 \times d_1$	<input type="checkbox"/>	<input checked="" type="checkbox"/>		<input type="checkbox"/>
	2.1	130	$0,004 \times d_1$	140	$0,005 \times d_1$	160	$0,005 \times d_1$	180	$0,006 \times d_1$	<input type="checkbox"/>	<input checked="" type="checkbox"/>		<input type="checkbox"/>
	2.2	130	$0,004 \times d_1$	140	$0,005 \times d_1$	160	$0,005 \times d_1$	180	$0,006 \times d_1$	<input type="checkbox"/>	<input checked="" type="checkbox"/>		<input type="checkbox"/>
	3.1	110	$0,004 \times d_1$	120	$0,005 \times d_1$	130	$0,005 \times d_1$	150	$0,006 \times d_1$	<input type="checkbox"/>	<input checked="" type="checkbox"/>		<input type="checkbox"/>
	3.2	110	$0,004 \times d_1$	120	$0,005 \times d_1$	130	$0,005 \times d_1$	150	$0,006 \times d_1$	<input type="checkbox"/>	<input checked="" type="checkbox"/>		<input type="checkbox"/>
	4.1	90	$0,003 \times d_1$	100	$0,003 \times d_1$	110	$0,004 \times d_1$	130	$0,004 \times d_1$	<input type="checkbox"/>	<input checked="" type="checkbox"/>		<input type="checkbox"/>
	4.2	70	$0,003 \times d_1$	80	$0,003 \times d_1$	80	$0,004 \times d_1$	100	$0,004 \times d_1$	<input type="checkbox"/>	<input checked="" type="checkbox"/>		<input type="checkbox"/>
N	1.1	220	$0,009 \times d_1$	250	$0,010 \times d_1$	280	$0,011 \times d_1$	300	$0,008 \times d_1$				<input checked="" type="checkbox"/>
	1.2	220	$0,008 \times d_1$	250	$0,009 \times d_1$	280	$0,010 \times d_1$	300	$0,008 \times d_1$				<input checked="" type="checkbox"/>
	1.3	220	$0,007 \times d_1$	250	$0,008 \times d_1$	280	$0,009 \times d_1$	300	$0,007 \times d_1$				<input checked="" type="checkbox"/>
	1.4												
	1.5												
	1.6												
	2.1	170	$0,007 \times d_1$	180	$0,007 \times d_1$	200	$0,008 \times d_1$	220	$0,008 \times d_1$			<input type="checkbox"/>	<input checked="" type="checkbox"/>
	2.2	170	$0,007 \times d_1$	180	$0,007 \times d_1$	200	$0,008 \times d_1$	220	$0,008 \times d_1$			<input type="checkbox"/>	<input checked="" type="checkbox"/>
	2.3	170	$0,007 \times d_1$	180	$0,007 \times d_1$	200	$0,008 \times d_1$	220	$0,008 \times d_1$	<input type="checkbox"/>	<input type="checkbox"/>	<input type="checkbox"/>	<input checked="" type="checkbox"/>
	2.4	160	$0,006 \times d_1$	170	$0,006 \times d_1$	180	$0,007 \times d_1$	200	$0,007 \times d_1$			<input type="checkbox"/>	<input checked="" type="checkbox"/>
	2.5	160	$0,006 \times d_1$	170	$0,006 \times d_1$	180	$0,007 \times d_1$	200	$0,007 \times d_1$			<input type="checkbox"/>	<input checked="" type="checkbox"/>
	2.6	160	$0,006 \times d_1$	170	$0,006 \times d_1$	180	$0,007 \times d_1$	200	$0,007 \times d_1$	<input type="checkbox"/>	<input type="checkbox"/>	<input type="checkbox"/>	<input checked="" type="checkbox"/>
	2.7	120	$0,004 \times d_1$	130	$0,004 \times d_1$	140	$0,005 \times d_1$	160	$0,005 \times d_1$			<input type="checkbox"/>	<input checked="" type="checkbox"/>
	2.8	100	$0,003 \times d_1$	110	$0,003 \times d_1$	120	$0,004 \times d_1$	140	$0,004 \times d_1$			<input type="checkbox"/>	<input checked="" type="checkbox"/>
	3.1												
	3.2												
4.1													
4.2													
4.3													
4.4													
5.1													
5.2	70	$0,003 \times d_1$	80	$0,004 \times d_1$	80	$0,005 \times d_1$	100	$0,005 \times d_1$			<input type="checkbox"/>	<input checked="" type="checkbox"/>	
5.3													
S	1.1	70	$0,005 \times d_1$	90	$0,005 \times d_1$	100	$0,006 \times d_1$	100	$0,005 \times d_1$				<input checked="" type="checkbox"/>
	1.2	60	$0,003 \times d_1$	70	$0,003 \times d_1$	80	$0,004 \times d_1$	90	$0,004 \times d_1$				<input checked="" type="checkbox"/>
	1.3	50	$0,002 \times d_1$	60	$0,002 \times d_1$	70	$0,003 \times d_1$	80	$0,003 \times d_1$				<input checked="" type="checkbox"/>
	2.1	60	$0,003 \times d_1$	70	$0,003 \times d_1$	80	$0,004 \times d_1$	90	$0,004 \times d_1$				<input checked="" type="checkbox"/>
	2.2	20	$0,002 \times d_1$	25	$0,002 \times d_1$	30	$0,003 \times d_1$	35	$0,003 \times d_1$				<input checked="" type="checkbox"/>
	2.3	15	$0,002 \times d_1$	20	$0,002 \times d_1$	25	$0,003 \times d_1$	30	$0,003 \times d_1$				<input checked="" type="checkbox"/>
	2.4	20	$0,002 \times d_1$	25	$0,002 \times d_1$	30	$0,003 \times d_1$	35	$0,003 \times d_1$				<input checked="" type="checkbox"/>
2.5	15	$0,002 \times d_1$	20	$0,002 \times d_1$	25	$0,003 \times d_1$	30	$0,003 \times d_1$				<input checked="" type="checkbox"/>	
2.6	15	$0,002 \times d_1$	20	$0,002 \times d_1$	25	$0,003 \times d_1$	30	$0,003 \times d_1$				<input checked="" type="checkbox"/>	
H	1.1	90	$0,003 \times d_1$	100	$0,003 \times d_1$	110	$0,003 \times d_1$	130	$0,004 \times d_1$	<input type="checkbox"/>	<input checked="" type="checkbox"/>		
	1.2	70	$0,002 \times d_1$	80	$0,003 \times d_1$	90	$0,003 \times d_1$	110	$0,004 \times d_1$	<input type="checkbox"/>	<input checked="" type="checkbox"/>		
	1.3												
	1.4												
	1.5												

■ = sehr gut geeignet · very suitable
□ = gut geeignet · suitable

V_c = Schnittgeschwindigkeit · Cutting speed
 f_z = Vorschub pro Zahn · Feed per tooth

- Hochleistungswerkzeug
- Spezielle Geometrie zum Hartfräsen
- Sehr stabile Werkzeugausführung
- Kurze Schneidenlänge
- Eingeschränkte Schneidendurchmesser-Toleranz
- 2 Baulängen verfügbar

- High performance tool
- Special geometry for hard milling
- Very stable tool design
- Short flute length
- Tighter cutting diameter tolerance
- 2 lengths available

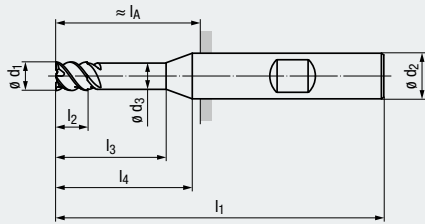
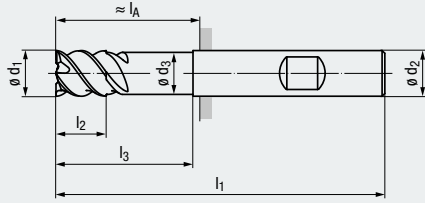

H

HM

DIN 6535
HA
HB

55°

KB x 45°

3-5°

44-66 HRC

Vc/fz
15



new



Hard materials

Beschichtung · Coating

Einsatzgebiete – Material (siehe Seite 4)

- In allen hochfesten Werkstoffen einsetzbar
- Hartbearbeitung bis 66 HRC möglich
- Zum HSC-Schlichten geeignet

Applications – material (see page 4)

- For all high-strength materials
- Hard machining of up to 66 HRC
- Suitable for HSC finishing

ALCR

P	3.1-5.1	1.1-2.1
K	1.1-4.2	
H	1.1-1.3	1.4-1.5

Lange Ausführung · Long design

Bestell-Code · Order code

3813L

$\varnothing d_1$ e8	l_2	l_3	l_1	$\varnothing d_3$	l_4	$\varnothing d_2$ h5	l_A	KB	Z (Flutes)	Dimens.- Code			
2	3	10	57	1,9	20	6	21	0,04	4	.002	●		
3	4	14	57	2,8	20	6	21	0,05	4	.003	●		
4	5	16	57	3,7	20	6	21	0,06	4	.004	●		
5	6	18	57	4,6	20	6	21	0,07	4	.005	●		
6	7	20	57	5,5	–	6	21	0,08	4	.006	●		
8	9	26	63	7,4	–	8	27	0,1	4	.008	●		
10	11	31	72	9,2	–	10	32	0,12	4	.010	●		
12	13	37	83	11	–	12	38	0,14	4	.012	●		
16	17	43	92	15	–	16	44	0,18	4	.016	●		
20	21	53	104	19	–	20	54	0,22	4	.020	●		



Hartmetall-Schafffräser „Base“ – lange Ausführung
Solid carbide end mills “Base” – long design

H

Gültig für · Valid for
3813L

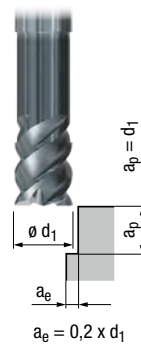
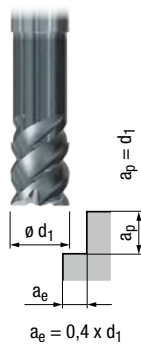
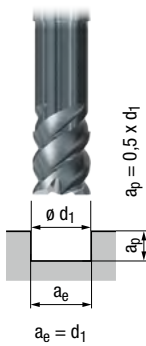

		Vc [m/min]		fz [mm]		Vc [m/min]		fz [mm]				MMS	MQL	
		1	2	1	2	1	2	1	2					
P	1.1	160	0,005 x d1	180	0,005 x d1	190	0,005 x d1	260	0,006 x d1	□	■	□	■	
	2.1	140	0,004 x d1	150	0,004 x d1	170	0,005 x d1	220	0,005 x d1	□	■	□	■	
	3.1	120	0,004 x d1	130	0,004 x d1	140	0,004 x d1	190	0,005 x d1	□	■	□	■	
	4.1	100	0,003 x d1	110	0,003 x d1	120	0,003 x d1	160	0,004 x d1	□	■			
	5.1	80	0,003 x d1	90	0,003 x d1	100	0,003 x d1	130	0,003 x d1	□	■			
M	1.1													
	2.1													
	3.1													
	4.1													
K	1.1	160	0,005 x d1	180	0,005 x d1	190	0,006 x d1	260	0,006 x d1	□	■			
	1.2	160	0,005 x d1	180	0,005 x d1	190	0,006 x d1	260	0,006 x d1	□	■			
	2.1	140	0,004 x d1	150	0,004 x d1	170	0,004 x d1	220	0,005 x d1	□	■			
	2.2	140	0,004 x d1	150	0,004 x d1	170	0,004 x d1	220	0,005 x d1	□	■			
	3.1	120	0,004 x d1	130	0,004 x d1	140	0,004 x d1	190	0,005 x d1	□	■			
	3.2	120	0,004 x d1	130	0,004 x d1	140	0,004 x d1	190	0,005 x d1	□	■			
	4.1	100	0,003 x d1	110	0,003 x d1	120	0,003 x d1	160	0,004 x d1	□	■			
	4.2	80	0,003 x d1	90	0,003 x d1	100	0,003 x d1	130	0,004 x d1	□	■			
N	1.1													
	1.2													
	1.3													
	1.4													
	1.5													
	1.6													
	2.1													
	2.2													
	2.3													
	2.4													
	2.5													
	2.6													
	2.7													
	2.8													
	3.1													
	3.2													
4.1														
4.2														
4.3														
4.4														
5.1														
5.2														
5.3														
S	1.1													
	1.2													
	1.3													
	2.1													
	2.2													
	2.6													
H	1.1	100	0,003 x d1	110	0,003 x d1	120	0,003 x d1	160	0,003 x d1	□	■			
	1.2	80	0,003 x d1	90	0,003 x d1	100	0,003 x d1	130	0,003 x d1	□	■			
	1.3	70	0,002 x d1	80	0,002 x d1	80	0,002 x d1	110	0,003 x d1	□	■			
	1.4	50	0,002 x d1	60	0,002 x d1	60	0,002 x d1	80	0,002 x d1	□	■			
	1.5	40	0,002 x d1	40	0,002 x d1	50	0,002 x d1	60	0,002 x d1	□	■			

■ = sehr gut geeignet · very suitable
□ = gut geeignet · suitable

Vc = Schnittgeschwindigkeit · Cutting speed
fz = Vorschub pro Zahn · Feed per tooth

- Hochleistungswerkzeug
- Spezielle Geometrie zum Hartfräsen
- Sehr stabile Werkzeugausführung
- Kurze Schneidenlänge
- Eingeschränkte Schneidendurchmesser-Toleranz
- 2 Baulängen verfügbar

- High performance tool
- Special geometry for hard milling
- Very stable tool design
- Short flute length
- Tighter cutting diameter tolerance
- 2 lengths available

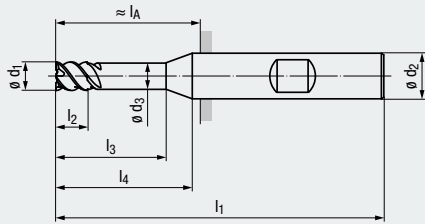
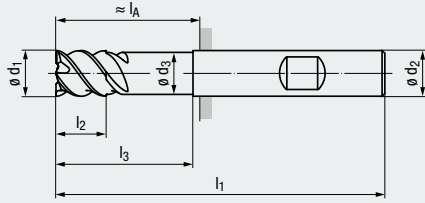

NEW



Hard materials

Beschichtung · Coating

Einsatzgebiete – Material (siehe Seite 4)

- In allen hochfesten Werkstoffen einsetzbar
- Hartbearbeitung bis 66 HRC möglich
- Zum HSC-Schlichten geeignet

Applications – material (see page 4)

- For all high-strength materials
- Hard machining of up to 66 HRC
- Suitable for HSC finishing

ALCR

P	3.1-5.1	1.1-2.1
K	1.1-4.2	
H	1.1-1.3	1.4-1.5

Extra lange Ausführung · Extra long design

Bestell-Code · Order code

$\varnothing d_1$	l_2	l_3	l_1	$\varnothing d_3$	l_4	$\varnothing d_2$	l_A	KB	Z	Dimens.-Code	3815L
e8						h5			(Flutes)		
3	4	15	70	2,8	30	6	34	0,05	4	.003	●
4	5	20	70	3,7	30	6	34	0,06	4	.004	●
5	6	25	70	4,6	30	6	34	0,07	4	.005	●
6	7	33	70	5,5	–	6	34	0,08	4	.006	●
8	9	43	80	7,4	–	8	44	0,1	4	.008	●
10	11	43	84	9,2	–	10	44	0,12	4	.010	●
12	13	51	97	11	–	12	52	0,14	4	.012	●
16	17	66	115	15	–	16	67	0,18	4	.016	●
20	21	79	130	19	–	20	80	0,22	4	.020	●



Hartmetall-Schafffräser „Base“ – extra lange Ausführung
Solid carbide end mills “Base” – extra long design

H

Gültig für · Valid for
3815L

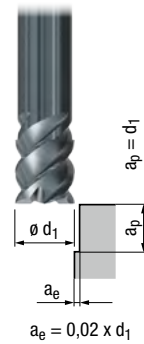
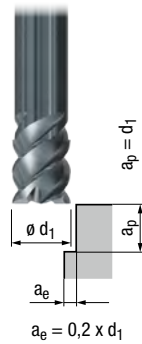
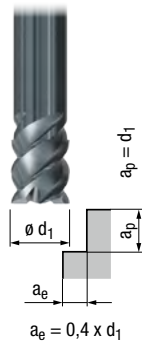
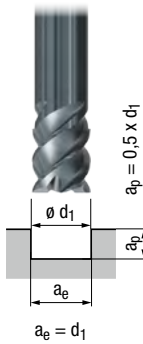

		V_c	f_z	V_c	f_z	V_c	f_z	V_c	f_z			MMS	
		[m/min]	[mm]	[m/min]	[mm]	[m/min]	[mm]	[m/min]	[mm]				
P	1.1	135	$0,005 \times d_1$	145	$0,005 \times d_1$	155	$0,005 \times d_1$	210	$0,006 \times d_1$	<input type="checkbox"/>	<input checked="" type="checkbox"/>	<input type="checkbox"/>	<input checked="" type="checkbox"/>
	2.1	110	$0,004 \times d_1$	120	$0,004 \times d_1$	140	$0,005 \times d_1$	180	$0,005 \times d_1$	<input type="checkbox"/>	<input checked="" type="checkbox"/>	<input type="checkbox"/>	<input checked="" type="checkbox"/>
	3.1	100	$0,004 \times d_1$	105	$0,004 \times d_1$	110	$0,004 \times d_1$	155	$0,005 \times d_1$	<input type="checkbox"/>	<input checked="" type="checkbox"/>	<input type="checkbox"/>	<input checked="" type="checkbox"/>
	4.1	80	$0,003 \times d_1$	90	$0,003 \times d_1$	100	$0,003 \times d_1$	135	$0,004 \times d_1$	<input type="checkbox"/>	<input checked="" type="checkbox"/>		
	5.1	65	$0,003 \times d_1$	75	$0,003 \times d_1$	80	$0,003 \times d_1$	105	$0,003 \times d_1$	<input type="checkbox"/>	<input checked="" type="checkbox"/>		
M	1.1												
	2.1												
	3.1												
	4.1												
K	1.1	135	$0,005 \times d_1$	145	$0,005 \times d_1$	155	$0,006 \times d_1$	210	$0,006 \times d_1$	<input type="checkbox"/>	<input checked="" type="checkbox"/>		
	1.2	135	$0,005 \times d_1$	145	$0,005 \times d_1$	155	$0,006 \times d_1$	210	$0,006 \times d_1$	<input type="checkbox"/>	<input checked="" type="checkbox"/>		
	2.1	110	$0,004 \times d_1$	120	$0,004 \times d_1$	140	$0,004 \times d_1$	180	$0,005 \times d_1$	<input type="checkbox"/>	<input checked="" type="checkbox"/>		
	2.2	110	$0,004 \times d_1$	120	$0,004 \times d_1$	140	$0,004 \times d_1$	180	$0,005 \times d_1$	<input type="checkbox"/>	<input checked="" type="checkbox"/>		
	3.1	100	$0,004 \times d_1$	105	$0,004 \times d_1$	110	$0,004 \times d_1$	155	$0,005 \times d_1$	<input type="checkbox"/>	<input checked="" type="checkbox"/>		
	3.2	100	$0,004 \times d_1$	105	$0,004 \times d_1$	110	$0,004 \times d_1$	155	$0,005 \times d_1$	<input type="checkbox"/>	<input checked="" type="checkbox"/>		
	4.1	80	$0,003 \times d_1$	90	$0,003 \times d_1$	100	$0,003 \times d_1$	135	$0,004 \times d_1$	<input type="checkbox"/>	<input checked="" type="checkbox"/>		
	4.2	65	$0,003 \times d_1$	75	$0,003 \times d_1$	80	$0,003 \times d_1$	105	$0,004 \times d_1$	<input type="checkbox"/>	<input checked="" type="checkbox"/>		
N	1.1												
	1.2												
	1.3												
	1.4												
	1.5												
	1.6												
	2.1												
	2.2												
	2.3												
	2.4												
	2.5												
	2.6												
	2.7												
	2.8												
	3.1												
	3.2												
4.1													
4.2													
4.3													
4.4													
5.1													
5.2													
5.3													
S	1.1												
	1.2												
	1.3												
	2.1												
	2.2												
	2.6												
H	1.1	80	$0,003 \times d_1$	90	$0,003 \times d_1$	100	$0,003 \times d_1$	135	$0,003 \times d_1$	<input type="checkbox"/>	<input checked="" type="checkbox"/>		
	1.2	65	$0,003 \times d_1$	75	$0,003 \times d_1$	80	$0,003 \times d_1$	105	$0,003 \times d_1$	<input type="checkbox"/>	<input checked="" type="checkbox"/>		
	1.3	60	$0,002 \times d_1$	65	$0,002 \times d_1$	65	$0,002 \times d_1$	90	$0,003 \times d_1$	<input type="checkbox"/>	<input checked="" type="checkbox"/>		
	1.4	40	$0,002 \times d_1$	50	$0,002 \times d_1$	50	$0,002 \times d_1$	65	$0,002 \times d_1$	<input type="checkbox"/>	<input checked="" type="checkbox"/>		
	1.5	30	$0,002 \times d_1$	35	$0,002 \times d_1$	40	$0,002 \times d_1$	50	$0,002 \times d_1$	<input type="checkbox"/>	<input checked="" type="checkbox"/>		

■ = sehr gut geeignet · very suitable
□ = gut geeignet · suitable

V_c = Schnittgeschwindigkeit · Cutting speed
 f_z = Vorschub pro Zahn · Feed per tooth

- Hochleistungswerkzeug
- Spezielle Geometrie für die Aluminiumzerspanung
- Schneiden zur Mitte

- High performance tool
- Special geometry for the machining of aluminium
- Centre cutting

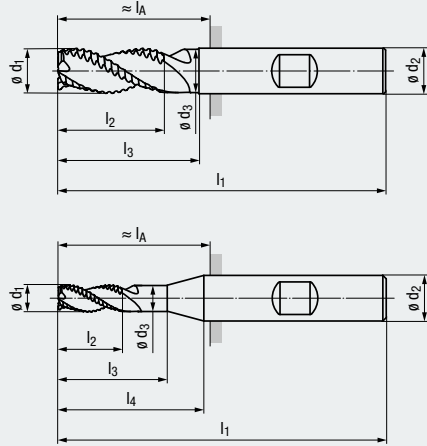
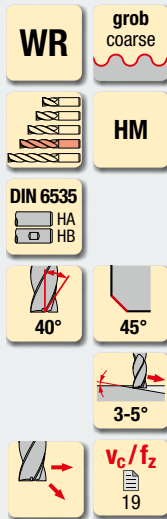

Al

Al/Cu

Beschichtung · Coating

Einsatzgebiete – Material (siehe Seite 4)

- Für Aluminium-Knetlegierungen
- Für Aluminium-Legierungen mit einem Siliziumgehalt bis 7%
- Mit GLT-Beschichtung auch in Kupfer-Legierungen einsetzbar

Applications – material (see page 4)

- For wrought aluminium alloys
- For aluminium alloys with a silicon content of up to 7%
- With GLT coating also for copper alloys

GLT

N 1.1-1.3 1.4

N 1.1-1.4 2.1-2.7

DIN 6527 – Lange Ausführung · Long design

Bestell-Code · Order code

$\emptyset d_1$ h11	l_2	l_3	l_1	$\emptyset d_3$	l_4	$\emptyset d_2$ h6	l_A	Z (Flutes)	Dimens.- Code	2548	2549	2548K	2549K
3	7	14	57	2,9	20	6	21	3	.003	●	●	●	●
4	8	18	57	3,8	20	6	21	3	.004	●	●	●	●
5	10	19	57	4,8	20	6	21	3	.005	●	●	●	●
6	13	20	57	5,8	–	6	21	3	.006	●	●	●	●
8	19	25	63	7,7	–	8	34	3	.008	●	●	●	●
10	22	30	72	9,5	–	10	32	3	.010	●	●	●	●
12	26	35	83	11,5	–	12	38	3	.012	●	●	●	●
16	32	40	92	15,5	–	16	44	3	.016	●	●	●	●
20	38	50	104	19,5	–	20	54	3	.020	●	●	●	●



Hartmetall-Schaftfräser „Base“ – lange Ausführung
Solid carbide end mills “Base” – long design

WR

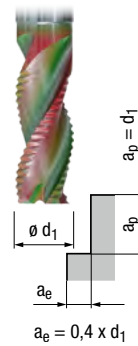
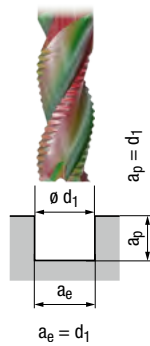

Gültig für · Valid for

- 2548
- 2548K
- 2549
- 2549K

Achtung:
Bei unbeschichteter Ausführung ist die Schnittgeschwindigkeit v_c um 30% zu reduzieren!

Please note:
For uncoated design, please reduce cutting speed v_c by 30%!



	v_c [m/min]	f_z [mm]	v_c [m/min]	f_z [mm]				
P	1.1							
	2.1							
	3.1							
	4.1							
	5.1							
M	1.1							
	2.1							
	3.1							
	4.1							
K	1.1							
	1.2							
	2.1							
	2.2							
	3.1							
	3.2							
	4.1							
N	1.1	300	$0,009 \times d_1$	420	$0,011 \times d_1$			■
	1.2	430	$0,008 \times d_1$	620	$0,010 \times d_1$			■
	1.3	385	$0,007 \times d_1$	550	$0,008 \times d_1$			■
	1.4	270	$0,008 \times d_1$	380	$0,010 \times d_1$			■
	1.5							
	1.6							
	2.1	100	$0,005 \times d_1$	160	$0,006 \times d_1$		□	■
	2.2	100	$0,005 \times d_1$	160	$0,006 \times d_1$		□	■
	2.3	100	$0,005 \times d_1$	160	$0,006 \times d_1$		□	■
	2.4	80	$0,004 \times d_1$	140	$0,005 \times d_1$		□	■
	2.5	80	$0,004 \times d_1$	140	$0,005 \times d_1$		□	■
	2.6	80	$0,004 \times d_1$	140	$0,005 \times d_1$		□	■
	2.7	60	$0,003 \times d_1$	100	$0,004 \times d_1$		□	■
	2.8							
	3.1							
	3.2							
4.1								
4.2								
4.3								
4.4								
5.1								
5.2								
5.3								
S	1.1							
	1.2							
	1.3							
	2.1							
	2.2							
	2.3							
	2.4							
2.5								
2.6								
H	1.1							
	1.2							
	1.3							
	1.4							
	1.5							

■ = sehr gut geeignet · very suitable
□ = gut geeignet · suitable

v_c = Schnittgeschwindigkeit · Cutting speed
 f_z = Vorschub pro Zahn · Feed per tooth

- Hochleistungswerkzeug
- Spezielle Geometrie für die Aluminiumzerspanung
- Vibrationsarme Bearbeitung
- Mit 2 und 3 Schneiden
- Schneiden zur Mitte

- High performance tool
- Special geometry for the machining of aluminium
- Low-vibration machining
- With 2 and 3 flutes
- Centre cutting

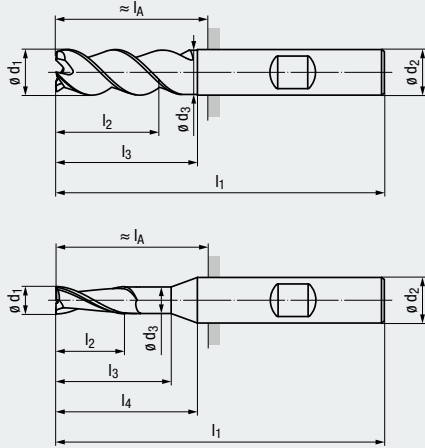

W

HM

DIN 6535
HA
HB

Z2
45°

Z3
38-40°

KB x 45°

v_c / f_z
21



Al

Al/Cu

Beschichtung · Coating

Einsatzgebiete – Material (siehe Seite 4)

- Für Aluminium-Knetlegierungen
- Für Aluminium-Legierungen mit einem Siliziumgehalt bis 7%
- Mit GLT-Beschichtung auch in Kupfer-Legierungen einsetzbar
- Zum Bohrfräsen geeignet
- Zum Schruppen und Schlichten geeignet

Applications – material (see page 4)

- For wrought aluminium alloys
- For aluminium alloys with a silicon content of up to 7%
- With GLT coating also for copper alloys
- Suitable for Z-axis milling
- Suitable for roughing and finishing

GLT

N 1.1-1.3 1.4

N 1.1-1.4 2.1-2.7

DIN 6527 – Lange Ausführung · Long design

Bestell-Code · Order code

											2544	2545	2544K	2545K
$\varnothing d_1$ h10	l_2	l_3	l_1	$\varnothing d_3$	l_4	$\varnothing d_2$ h6	l_A □	KB	Z (Flutes)	Dimens.- Code				
2	6	10	57	1,9	20	6	21	0,04	2	.002	●	●	●	●
3	7	14	57	2,9	20	6	21	0,07	2	.003	●	●	●	●
4	8	18	57	3,8	20	6	21	0,07	2	.004	●	●	●	●
5	10	18	57	4,8	20	6	21	0,12	2	.005	●	●	●	●
6	13	20	57	5,8	–	6	21	0,12	3	.006	●	●	●	●
8	19	25	63	7,7	–	8	34	0,12	3	.008	●	●	●	●
10	22	30	72	9,5	–	10	32	0,2	3	.010	●	●	●	●
12	26	35	83	11,5	–	12	38	0,2	3	.012	●	●	●	●
16	32	40	92	15,5	–	16	44	0,2	3	.016	●	●	●	●
20	38	50	104	19,5	–	20	54	0,3	3	.020	●	●	●	●



Hartmetall-Schaftfräser „Base“ – lange Ausführung
Solid carbide end mills “Base” – long design

W

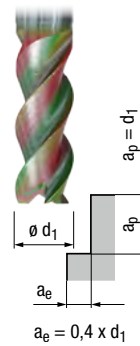
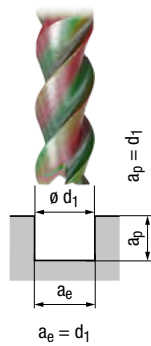

Gültig für · Valid for

- 2544
- 2544K
- 2545
- 2545K

Achtung:
Bei unbeschichteter Ausführung ist die Schnittgeschwindigkeit v_c um 30% zu reduzieren!

Please note:
For uncoated design, please reduce cutting speed v_c by 30%!



	v_c [m/min]	f_z [mm]	v_c [m/min]	f_z [mm]			
P	1.1						
	2.1						
	3.1						
	4.1						
	5.1						
M	1.1						
	2.1						
	3.1						
	4.1						
K	1.1						
	1.2						
	2.1						
	2.2						
	3.1						
	3.2						
	4.1						
N	1.1	300	0,006 x d_1	420	0,011 x d_1	<input type="checkbox"/>	<input checked="" type="checkbox"/>
	1.2	430	0,005 x d_1	620	0,010 x d_1	<input type="checkbox"/>	<input checked="" type="checkbox"/>
	1.3	385	0,005 x d_1	550	0,008 x d_1	<input type="checkbox"/>	<input checked="" type="checkbox"/>
	1.4	270	0,005 x d_1	380	0,010 x d_1	<input type="checkbox"/>	<input checked="" type="checkbox"/>
	1.5						
	1.6						
	2.1	100	0,005 x d_1	160	0,006 x d_1	<input type="checkbox"/>	<input checked="" type="checkbox"/>
	2.2	100	0,005 x d_1	160	0,006 x d_1	<input type="checkbox"/>	<input checked="" type="checkbox"/>
	2.3	100	0,005 x d_1	160	0,006 x d_1	<input type="checkbox"/>	<input checked="" type="checkbox"/>
	2.4	80	0,004 x d_1	140	0,005 x d_1	<input type="checkbox"/>	<input checked="" type="checkbox"/>
	2.5	80	0,004 x d_1	140	0,005 x d_1	<input type="checkbox"/>	<input checked="" type="checkbox"/>
	2.6	80	0,004 x d_1	140	0,005 x d_1	<input type="checkbox"/>	<input checked="" type="checkbox"/>
	2.7	60	0,003 x d_1	100	0,004 x d_1	<input type="checkbox"/>	<input checked="" type="checkbox"/>
	2.8						
	3.1						
	3.2						
4.1							
4.2							
4.3							
4.4							
5.1							
5.2							
5.3							
S	1.1						
	1.2						
	1.3						
	2.1						
	2.2						
	2.3						
	2.6						
H	1.1						
	1.2						
	1.3						
	1.4						
	1.5						

■ = sehr gut geeignet · very suitable
□ = gut geeignet · suitable

v_c = Schnittgeschwindigkeit · Cutting speed
 f_z = Vorschub pro Zahn · Feed per tooth

- Hochleistungswerkzeug
- Spezielle Geometrie für die Aluminiumzerspanung
- Vibrationsarme Bearbeitung
- Verschiedene Eckenradien pro Schneidendurchmesser
- Schneiden zur Mitte

- High performance tool
- Special geometry for the machining of aluminium
- Low-vibration machining
- Several corner radii per cutting diameter
- Centre cutting

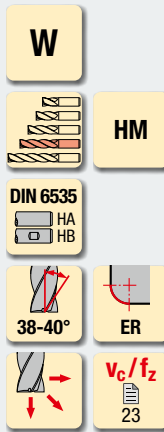

Al



Al/Cu

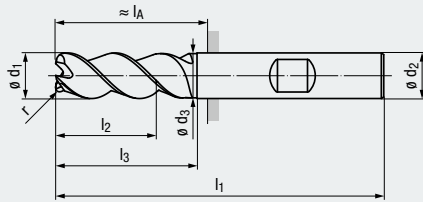

Beschichtung · Coating

Einsatzgebiete – Material (siehe Seite 4)

- Für Aluminium-Knetlegierungen
- Für Aluminium-Legierungen mit einem Siliziumgehalt bis 7%
- Mit GLT-Beschichtung auch in Kupfer-Legierungen einsetzbar
- Zum Bohrfräsen geeignet
- Zum Schruppen und Schlichten geeignet

Applications – material (see page 4)

- For wrought aluminium alloys
- For aluminium alloys with a silicon content of up to 7%
- With GLT coating also for copper alloys
- Suitable for Z-axis milling
- Suitable for roughing and finishing

GLT

N 1.1-1.3 1.4

N 1.1-1.4 2.1-2.7

DIN 6527 – Lange Ausführung · Long design

Eckenradius · Corner radius

Bestell-Code · Order code

										2546	2547	2546K	2547K
$\varnothing d_1$ h10	r $\pm 0,02$	l_2	l_3	l_1	$\varnothing d_3$	$\varnothing d_2$ h6	l_A 	Z (Flutes)	Dimens.- Code				
6	0,5	13	20	57	5,8	6	21	3	.006005	●	●	●	●
6	1	13	20	57	5,8	6	21	3	.006010	●	●	●	●
8	1	19	25	63	7,7	8	27	3	.008010	●	●	●	●
8	1,5	19	25	63	7,7	8	27	3	.008015	●	●	●	●
8	2	19	25	63	7,7	8	27	3	.008020	●	●	●	●
10	1	22	30	72	9,5	10	32	3	.010010	●	●	●	●
10	1,5	22	30	72	9,5	10	32	3	.010015	●	●	●	●
10	2	22	30	72	9,5	10	32	3	.010020	●	●	●	●
12	1	26	35	83	11,5	12	38	3	.012010	●	●	●	●
12	1,5	26	35	83	11,5	12	38	3	.012015	●	●	●	●
12	2	26	35	83	11,5	12	38	3	.012020	●	●	●	●
12	2,5	26	35	83	11,5	12	38	3	.012025	●	●	●	●
12	3	26	35	83	11,5	12	38	3	.012030	●	●	●	●
12	4	26	35	83	11,5	12	38	3	.012040	●	●	●	●
16	1	32	40	92	15,5	16	44	3	.016010	●	●	●	●
16	1,5	32	40	92	15,5	16	44	3	.016015	●	●	●	●
16	2	32	40	92	15,5	16	44	3	.016020	●	●	●	●
16	2,5	32	40	92	15,5	16	44	3	.016025	●	●	●	●
16	3	32	40	92	15,5	16	44	3	.016030	●	●	●	●
16	4	32	40	92	15,5	16	44	3	.016040	●	●	●	●
20	1	38	50	104	19,5	20	54	3	.020010	●	●	●	●
20	1,5	38	50	104	19,5	20	54	3	.020015	●	●	●	●
20	2	38	50	104	19,5	20	54	3	.020020	●	●	●	●
20	2,5	38	50	104	19,5	20	54	3	.020025	●	●	●	●
20	3	38	50	104	19,5	20	54	3	.020030	●	●	●	●
20	4	38	50	104	19,5	20	54	3	.020040	●	●	●	●

Andere Eckenradien auf Anfrage lieferbar
Other corner radii available on request



Hartmetall-Schaftfräser „Base“ – lange Ausführung
Solid carbide end mills “Base” – long design

W

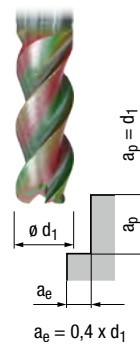
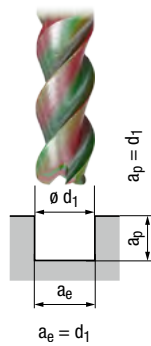

Gültig für · Valid for

- 2546
- 2546K
- 2547
- 2547K

Achtung:
Bei unbeschichteter Ausführung ist die Schnittgeschwindigkeit v_c um 30% zu reduzieren!

Please note:
For uncoated design, please reduce cutting speed v_c by 30%!



	v_c [m/min]	f_z [mm]	v_c [m/min]	f_z [mm]				
P	1.1							
	2.1							
	3.1							
	4.1							
	5.1							
M	1.1							
	2.1							
	3.1							
	4.1							
K	1.1							
	1.2							
	2.1							
	2.2							
	3.1							
	3.2							
	4.1							
N	1.1	300	$0,006 \times d_1$	420	$0,011 \times d_1$			■
	1.2	430	$0,005 \times d_1$	620	$0,010 \times d_1$			■
	1.3	385	$0,005 \times d_1$	550	$0,008 \times d_1$			■
	1.4	270	$0,005 \times d_1$	380	$0,010 \times d_1$			■
	1.5							
	1.6							
	2.1	100	$0,005 \times d_1$	160	$0,006 \times d_1$		□	■
	2.2	100	$0,005 \times d_1$	160	$0,006 \times d_1$		□	■
	2.3	100	$0,005 \times d_1$	160	$0,006 \times d_1$		□	■
	2.4	80	$0,004 \times d_1$	140	$0,005 \times d_1$		□	■
	2.5	80	$0,004 \times d_1$	140	$0,005 \times d_1$		□	■
	2.6	80	$0,004 \times d_1$	140	$0,005 \times d_1$		□	■
	2.7	60	$0,003 \times d_1$	100	$0,004 \times d_1$		□	■
	2.8							
	3.1							
	3.2							
4.1								
4.2								
4.3								
4.4								
5.1								
5.2								
5.3								
S	1.1							
	1.2							
	1.3							
	2.1							
	2.2							
	2.6							
H	1.1							
	1.2							
	1.3							
	1.4							
	1.5							

■ = sehr gut geeignet · very suitable
□ = gut geeignet · suitable

v_c = Schnittgeschwindigkeit · Cutting speed
 f_z = Vorschub pro Zahn · Feed per tooth

Durch die Verwendung von gekühlter Luft wird die Temperatur im Schneidenbereich herabgesetzt, wodurch höhere Schnittgeschwindigkeiten und Standzeiten erreicht werden können. Moderne Beschichtungen können durch diese Art der Kühlung erst alle Vorteile ausspielen, da eine Schädigung der Schneide durch Thermoschock vermieden wird.

Darüber hinaus werden die beim Kopierfräsen anfallenden sehr leichten Späne auch aus tiefen Aussparungen oder Kavitäten mit Hilfe der Kaltluftdüse entfernt.

Die Wirkungsweise der Kaltluftdüse basiert auf dem Prinzip des Wirbelrohrs, in dem zwei gegenläufige, rotierende Luftströme (ohne bewegte Teile) erzeugt werden. An einem Ende tritt die innere Strömung als nutzbare Kaltluft mit bis zu -40 °C aus. Der Anschluss erfolgt über einen Druckluftanschluss.

Cooled air reduces temperatures in the cutting area, which in turn permits higher cutting speeds and longer tool life. This type of cooling enables modern coatings to achieve their full potential, as damage to the cutting edge resulting from thermal shock is avoided.

Moreover, the cold-air nozzle helps to remove the tiny chips produced in copy milling even from deep recesses or cavities.

The function of the cold-air nozzle is based on the principle of the vortex tube, in which two opposed, rotating air streams are generated (without any moving parts). The internal air stream exits from one end, in the form of useable cold air with a temperature as low as -40 °C. All that is required is a normal pressurised air connection.

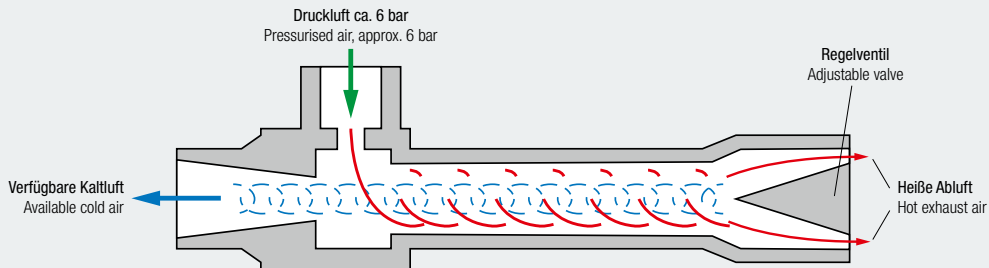

Temperatur gemessen am effektiven Austritt des Wirbelrohrs (nicht Düsenende)
Temperature, measured at the effective exit of the vortex tube (not the end of the nozzle)

Zuluft-Druck Supply air pressure [bar]	Temperatur der Nutzluft in °C bei einem Kaltluftanteil von Temperature of usable air in °C, with a cold air percentage of		
	25%	50%	75%
3	-31	-22	- 6
4	-35	-35	- 8
5	-39	-28	-10
6	-42	-31	-11
7	-46	-34	-13

Luftverbrauch bei Eingangstemperatur von 21 °C
Air consumption, with supply air temperature of 21 °C

Eingangsdruck Input pressure [bar]	Luftverbrauch Air consumption	Kapazität Capacity
6,9	7,08 l/s \cong 25,5 m ³ /h	226 kcal/h \cong 263 W

**Anwendungsbeispiel:
Standzeiterhöhung durch den Einsatz der Kaltluftdüse**

Werkstück: Formeinsatz gehärtet, Material K360 mit 63 HRC
Bearbeitung: Schichten des Formeinsatzes
Werkzeug: FRANKEN Hard-Cut
Schneidendurchmesser 10 mm, 2 Schneiden

Schnittwerte: $v_c = 240 \text{ m/min} \cdot n = 7639 \text{ min}^{-1}$
 $f_z = 0,12 \text{ mm} \cdot v_f = 1833 \text{ mm/min}$
 $a_p = 0,2 \text{ mm} \cdot a_e = 0,2 \text{ mm}$

Standzeit ohne Kühlung	Standzeit mit Kaltluftdüse
98 Minuten	130 Minuten

Durch den Einsatz der Kaltluftdüse konnte die Standzeit um 33% erhöht werden.

**Application example:
Increased tool life using the cold-air nozzle**

Workpiece: Hardened mould, material K360 with 63 HRC
Operation: Finishing the mould
Tool: FRANKEN Hard-Cut
Cutting diameter 10 mm, 2 flutes

Cutting conditions: $v_c = 240 \text{ m/min} \cdot n = 7639 \text{ rpm}$
 $f_z = 0.12 \text{ mm} \cdot v_f = 1833 \text{ mm/min}$
 $a_p = 0.2 \text{ mm} \cdot a_e = 0.2 \text{ mm}$

Tool life without coolant	Tool life with cold-air nozzle
98 minutes	130 minutes

By using the cold-air nozzle, it was possible to increase the tool life by 33%.





Lieferumfang:

- Mit biegsamem Schlauch (Länge ca. 300 mm) für kalte Nutzluft
- Schalldämpfer (SN14) für heiße Abluft
- Kugelhahn mit Anschlussstück (ST 1/4) für Zuluftschlauch (NW6) mit Schnellwechselkupplung (NW7.2)

Delivery includes:

- With flexible hose (length approx. 300 mm) for cold air
- Silencer (SN14) for hot exhaust air
- Ball-valve with fitting (1/4") for inlet hose (6 mm) with quick-change attachment (7.2 mm)

Bestell-Code · Order code		6910
Länge (ohne Schlauch) Length (without hose)	Dimens.- Code	
225 mm	.15	●

Ersatzschlauch
Spare Hose



Bestell-Code · Order code		6910
Länge Length	Dimens.- Code	
≈ 300 mm	.20	●
≈ 400 mm	.22	●
≈ 500 mm	.21	●

Halterungen für die Kaltluftdüse
Holders for the Cold-Air Nozzle



Klemmarm mit Grundhalter
Socket with basic holder



Klemmarm mit Magnethalter
Socket with magnetic shoe



Klemmarm
Socket



Grundhalter für Klemmarm
Basic holder for socket



Magnethalter für Klemmarm
Magnetic shoe for socket



Bestell-Code · Order code		6910			
Abmaße Dimensions	Dimens.- Code				
ø 45 x 68 mm	.24	●			
ø 80 x 80 mm	.25		●		
ø 80 x 17 mm	.26				●
ø 32 x 63 mm	.27			●	
ø 45 x 20 mm	.32				●

	P	M	K	N	S	H
Werkzeugtyp Tool type	Hochleistungsfräser-Programm High performance end mill programme					
NR	Multi-Cut	Multi-Cut	Multi-Cut			
NF	Jet-Cut	TiNox-Cut	Jet-Cut		TiNox-Cut	
N	Jet-Cut	TiNox-Cut	Jet-Cut		TiNox-Cut	
W				Alu-Cut		
W				Fiber-Cut		
WR				Alu-Cut		
H						Hard-Cut
Werkzeugtyp Tool type	Hochleistungs-Universalfräser-Programm High performance universal end mill programme					
N	TOP-Cut	TOP-Cut	TOP-Cut	TOP-Cut	TOP-Cut	TOP-Cut

Druckerzeugnisse für Hochleistungswerkzeuge

Sales literature for high performance end mills

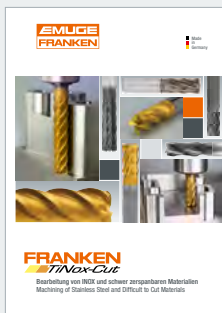

Druckerzeugnisse für Fräswerkzeuge mit besonderen Eigenschaften

Sales literature for milling tools with special characteristics



Hauptkatalog

Main catalogue

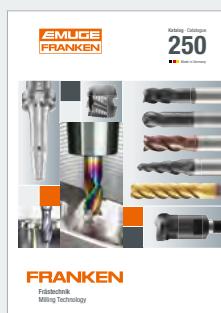

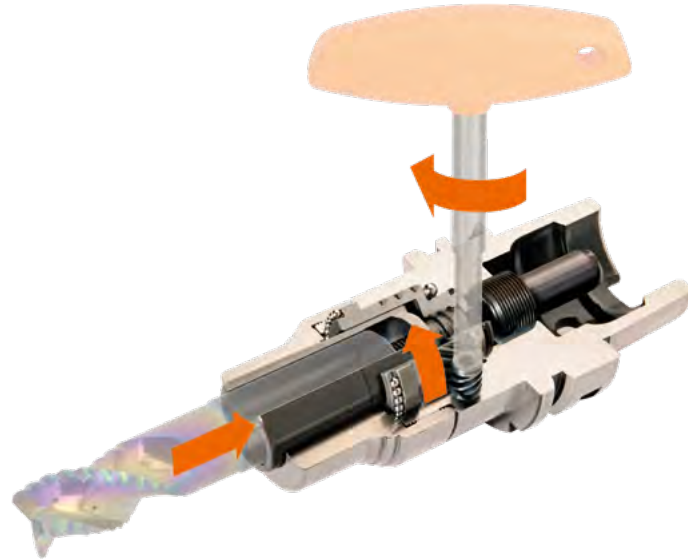

Beschreibung

Die patentierten Präzisions-Spannhülsen-Aufnahmen FPC und FMC sind hochgenaue Werkzeug-Aufnahmen mit mechanischer Klemmung für höchste Spannkraft und Rundlaufgenauigkeit sowie mit sehr guten Dämpfungseigenschaften. Die Werkzeugspannung erfolgt mittels Spannhülsen.

Das Spannen und Lösen des Werkzeugs geschieht

- bei der Präzisions-Spannhülsen-Aufnahme FPC mit einem Sechskantschlüssel, welcher seitlich den Spannmechanismus bedient – und das innerhalb weniger Sekunden,
- bei der Micro-Präzisions-Spannhülsen-Aufnahme FMC von hinten durch die Werkzeug-Aufnahme hindurch.

Es können alle Zylinderschäfte nach DIN 6535 oder DIN 1835 gespannt werden.

Die Präzisions-Spannhülsen-Aufnahmen FPC und FMC eignen sich hervorragend zum Hochleistungs- und Hochgeschwindigkeitsfräsen. Darüber hinaus können diese auch zum Bohren, Reiben oder zur Gewindeherstellung eingesetzt werden.

Description

The patented high precision collet holders FPC and FMC are highly precise tool holders with mechanical clamping which provide superior clamping force and concentricity as well as excellent shock-absorbing properties. The tools are clamped via collets.

The tools are clamped and unclamped

- with the high precision collet holder FPC using a hexagon wrench, which operates the clamping mechanism at the side – and in just a few seconds,
- with the micro precision collet holder FMC from the rear through the tool holder

All straight shanks according to DIN 6535 or DIN 1835 can be clamped.

The high precision collet holders FPC and FMC are well suited for high-performance and high-speed milling. In addition they can be used for drilling, reaming and threading operations.

Vorteile

- **Sicher**
Ein extrem hohes übertragbares Drehmoment sorgt für maximale Prozesssicherheit. Bei einem Werkzeug-Schaftdurchmesser von 20 mm liegt das übertragbare Drehmoment bei 600 Nm.
- **μ-genau**
Bei einer Auskraglänge des Werkzeuges von $3 \times D_1$ liegt die Rundlaufgenauigkeit $\leq 3 \mu\text{m}$. Dies garantiert zuverlässige Standzeiten und Oberflächengüten.
- **Höhere Standzeiten der Werkzeuge**
Die bei der Zerspanung entstehenden Vibrationen werden durch die besondere Konstruktion der Spannhülsen-Aufnahmen reduziert. Dieser Effekt führt zu besseren Oberflächen am Werkstück und sorgt für höchste Standzeiten.
- **Schneller Werkzeugwechsel**
Spannhülse mit eingesetztem Werkzeug in die Aufnahme eindrehen und Spannmechanismus betätigen.

Advantages

- **Reliable**
An extremely high transferable torque provides maximum process reliability. The transferred torque on a tool shank diameter of 20 mm is 600 Nm.
- **μ accurate**
With a projection length of the tool of $3 \times D_1$ the concentricity is $\leq 3 \mu\text{m}$. This guarantees reliable tool lives and surface qualities.
- **Longer tool life**
The vibrations generated by the machining process are reduced by means of the special technical design of the tool holder. This feature results in improved surfaces on the workpiece and ensures an excellent tool life.
- **Fast tool change**
Twist the collet with tool inserted into the holder and operate the clamping mechanism.

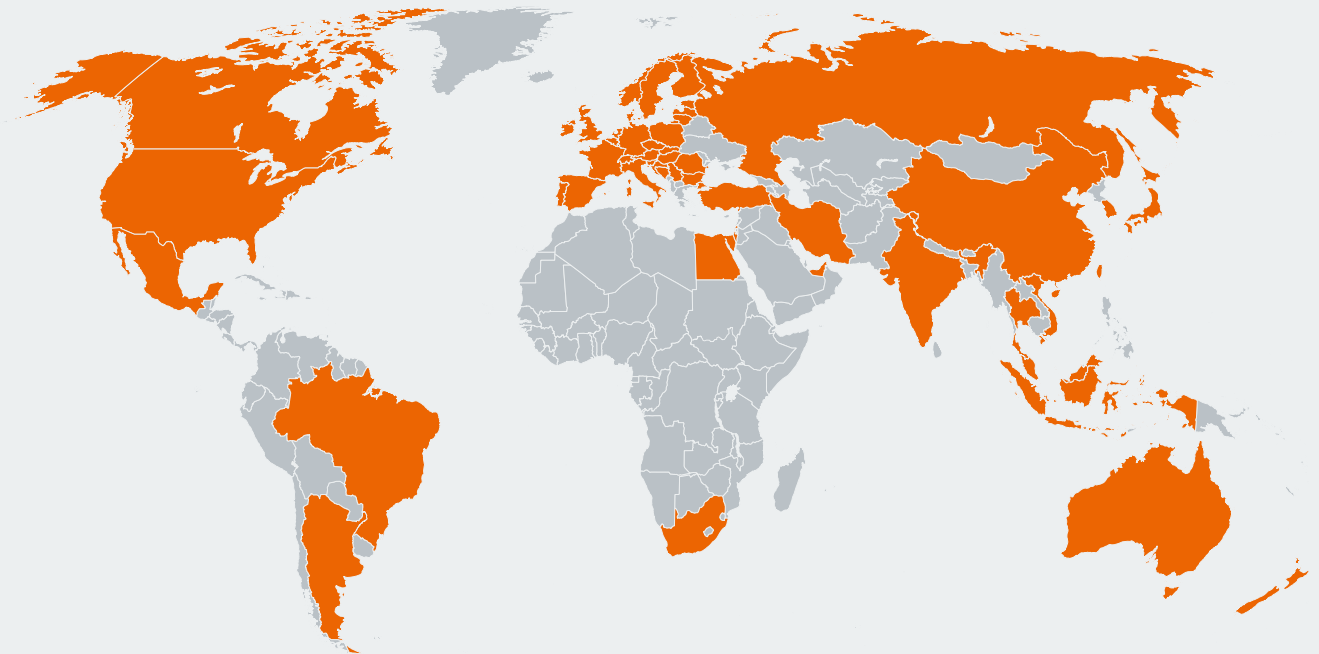

EMUGE-FRANKEN Vertriebspartner finden Sie auf www.emuge-franken.com/vertrieb
EMUGE-FRANKEN sales partners, please see www.emuge-franken.com/sales

EMUGE-Werk Richard Glimpel GmbH & Co. KG
Fabrik für Präzisionswerkzeuge

🏠 Nürnberger Straße 96-100
91207 Lauf
GERMANY

☎ +49 9123 186-0
📠 +49 9123 14313

FRANKEN GmbH & Co. KG
Fabrik für Präzisionswerkzeuge

🏠 Frankenstraße 7/9a
90607 Rückersdorf
GERMANY

☎ +49 911 9575-5
📠 +49 911 9575-327